

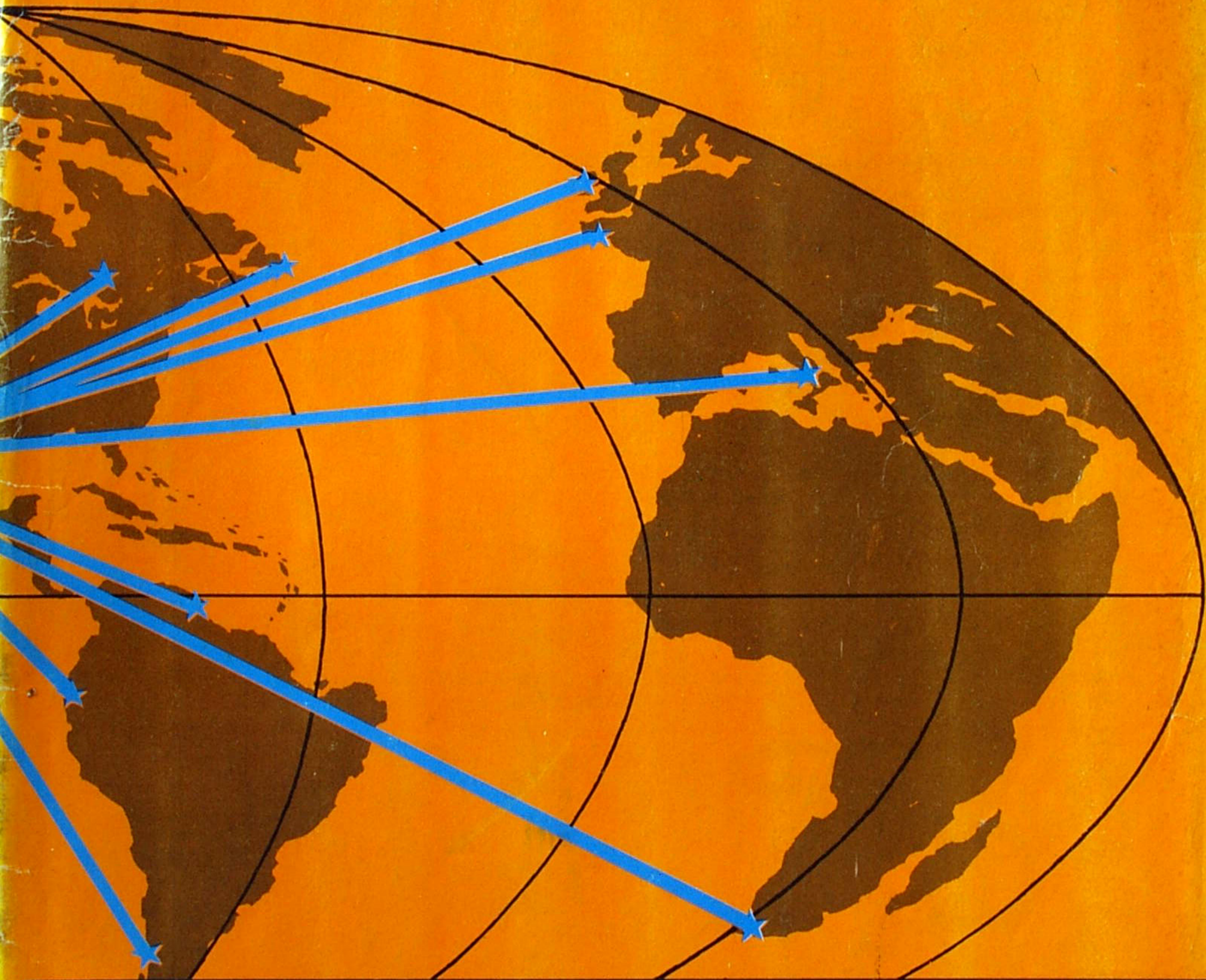

# **SPORTSWAYS, INC.**

7701 E. COMPTON BLVD. • PARAMOUNT, CALIF.



# **CHAMPION EXERCISERS, INC.**

A Subsidiary of SPORTSWAYS, INC.

7701 E. COMPTON BLVD. • PARAMOUNT, CALIFORNIA



# WATERLUNG REGULATORS

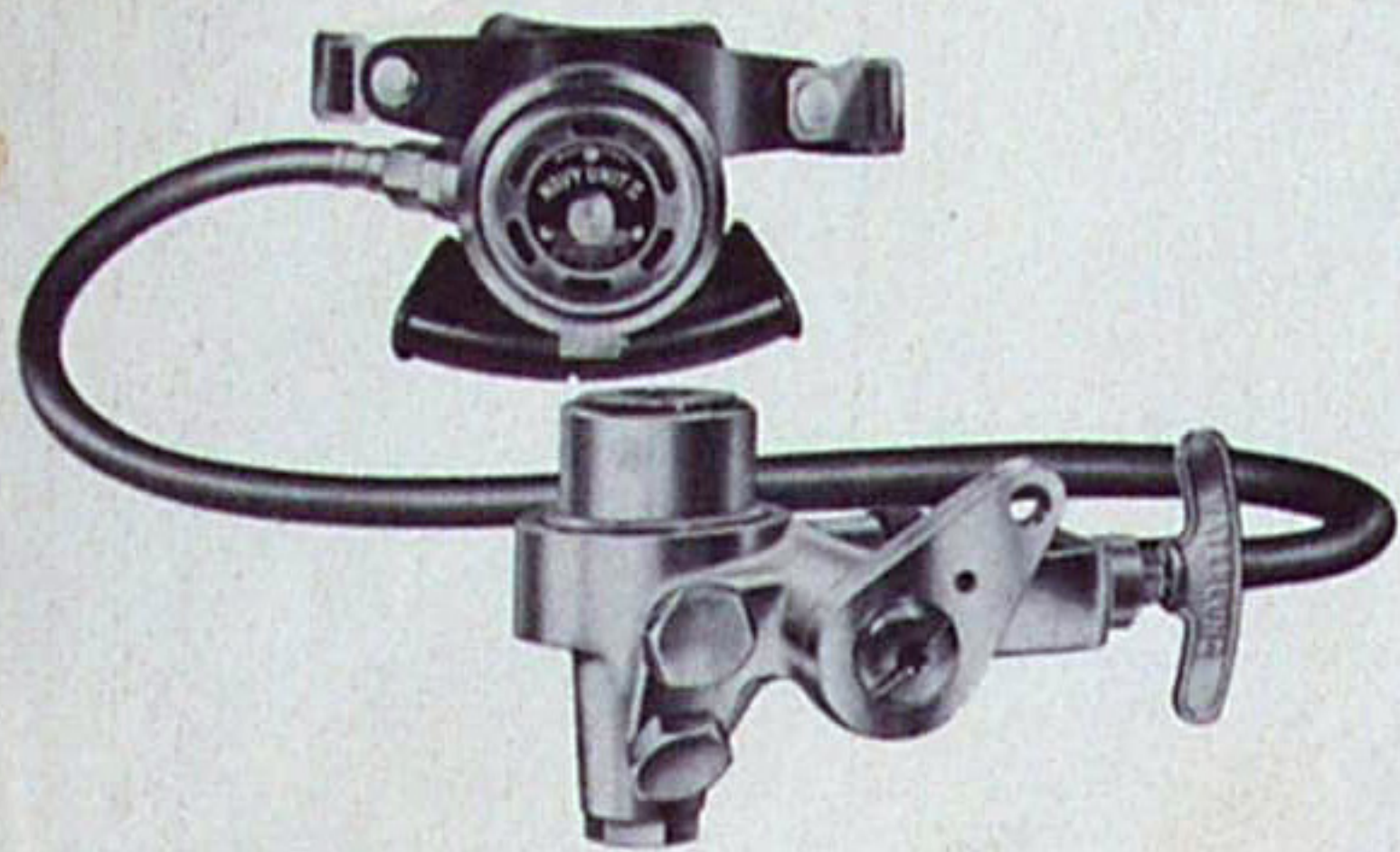

## NAVY UNIT II

### Outstanding Features:

Another SPORTSWAYS first — Positive cam-activated, spring-loaded reserve mechanism is an integral part of solid first stage body. Second stage has refined "downstream" valve design.

All moving parts made of stainless steel treated with SPORTSWAYS DRY-LUBE to reduce friction and wear.

Triple plated chrome inside and outside.

1375 "Navy Unit II" WATERLUNG Regulator.....	\$ 92.00
1376 "Navy Unit II" with Sea Vue Gauge.....	112.00
1377 "Navy Unit II" for use with double tank.....	92.00
1378 "Navy Unit II" for use with double tank units with Sea Vue Gauge.....	112.00
1374 "Navy Unit II" First Stage Only.....	60.00

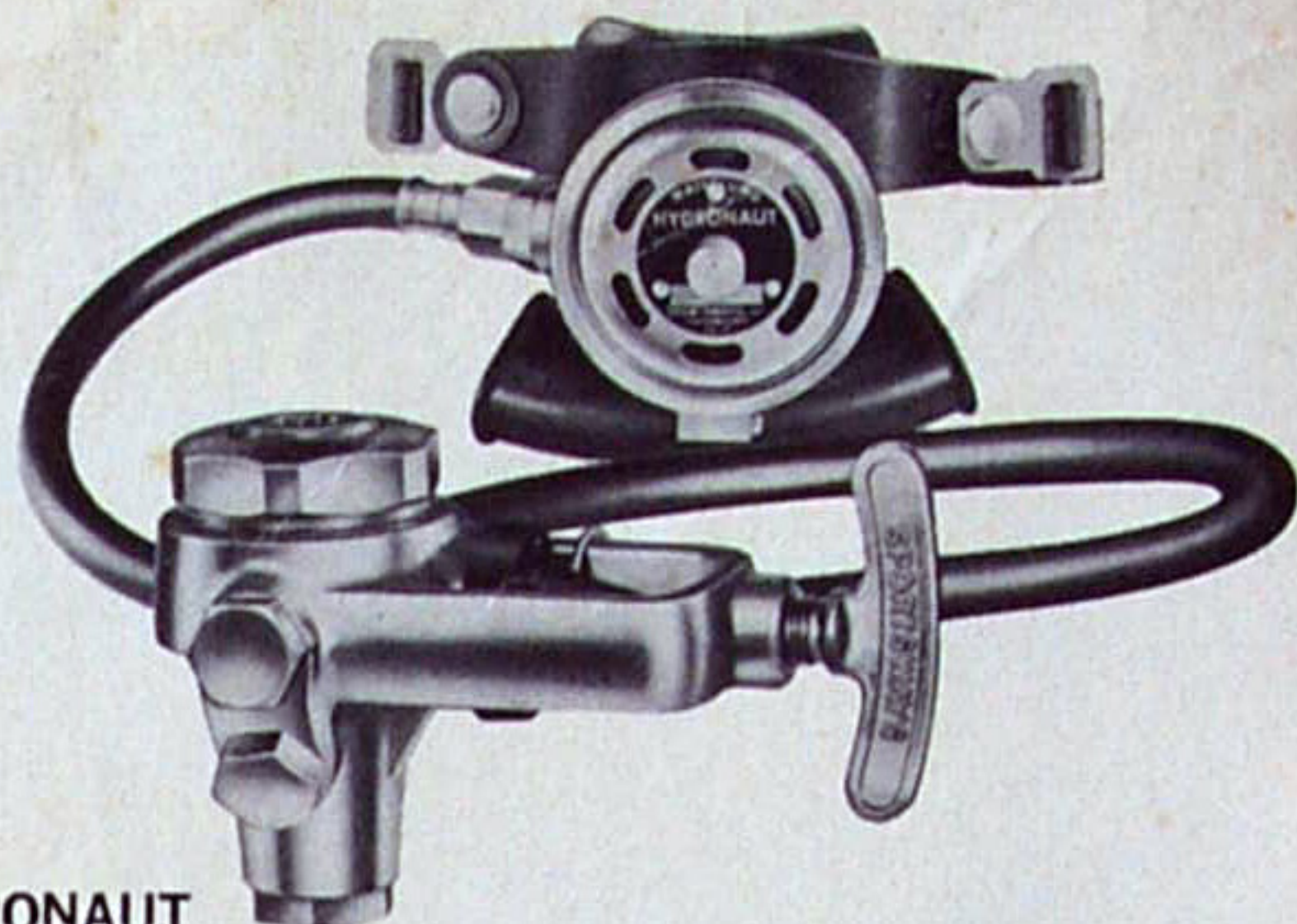

## HYDRONAUT

### Outstanding Features:

New concept in balanced breathing allows constant pressure and flow regardless of tank pressure.

Second stage "downstream" valve delivers 22 cu. ft. of air with an effort too small to be measured.

All vital metal parts made of stainless steel for highest tensile strength. Moving parts coated with the new SPORTSWAYS DRY-LUBE, an anti-friction agent.

Triple-plated chrome inside and outside.

1340 "Hydronaut" Waterlung Regulator.....	\$70.00
1341 "Hydronaut" Waterlung with Sea-View Gauge.....	94.00



## HYDRO-TWIN II

The only two-hose regulator made with these predominant features:

First stage "balanced valve".

Large demand diaphragm provides super-sensitive response.

Sea-View Gauge port. Solid one piece forging.

All vital metal parts made of stainless steel.

1350 "Hydro Twin II" WATERLUNG Regulator.....	\$ 94.00
1351 "Hydro Twin II" with Sea Vue Gauge.....	115.00

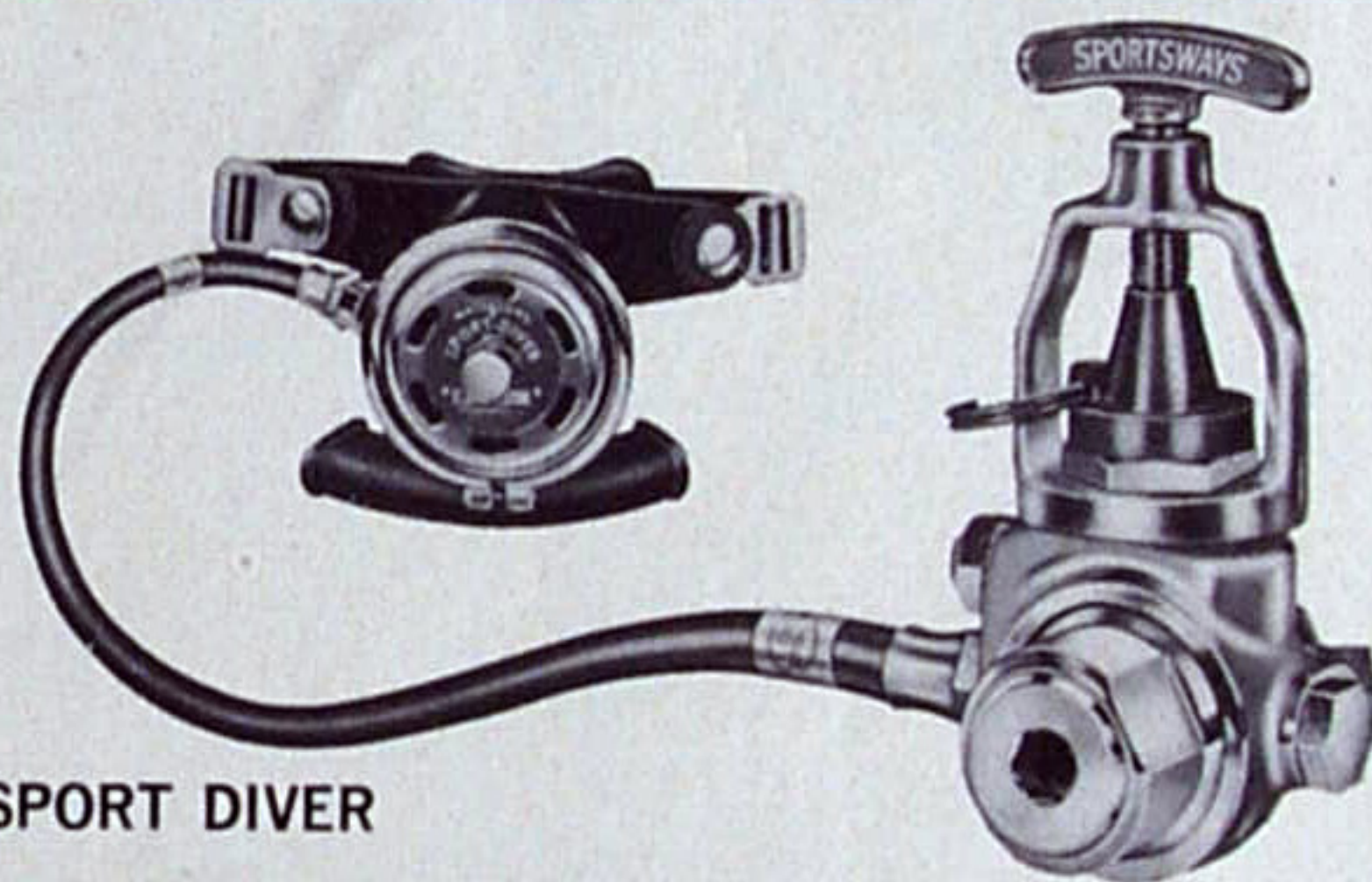

## SPORT DIVER

### Outstanding Features:

The world's most popular regulator EZ breathe rocker valve assembly makes this the best selling single hose regulator on the market today. Solid brass forging, chrome plated inside and outside.

1301 "Sport Diver" Waterlung Regulator.....	\$58.00
1302 "Sport Diver" with Sea-View Gauge.....	82.00

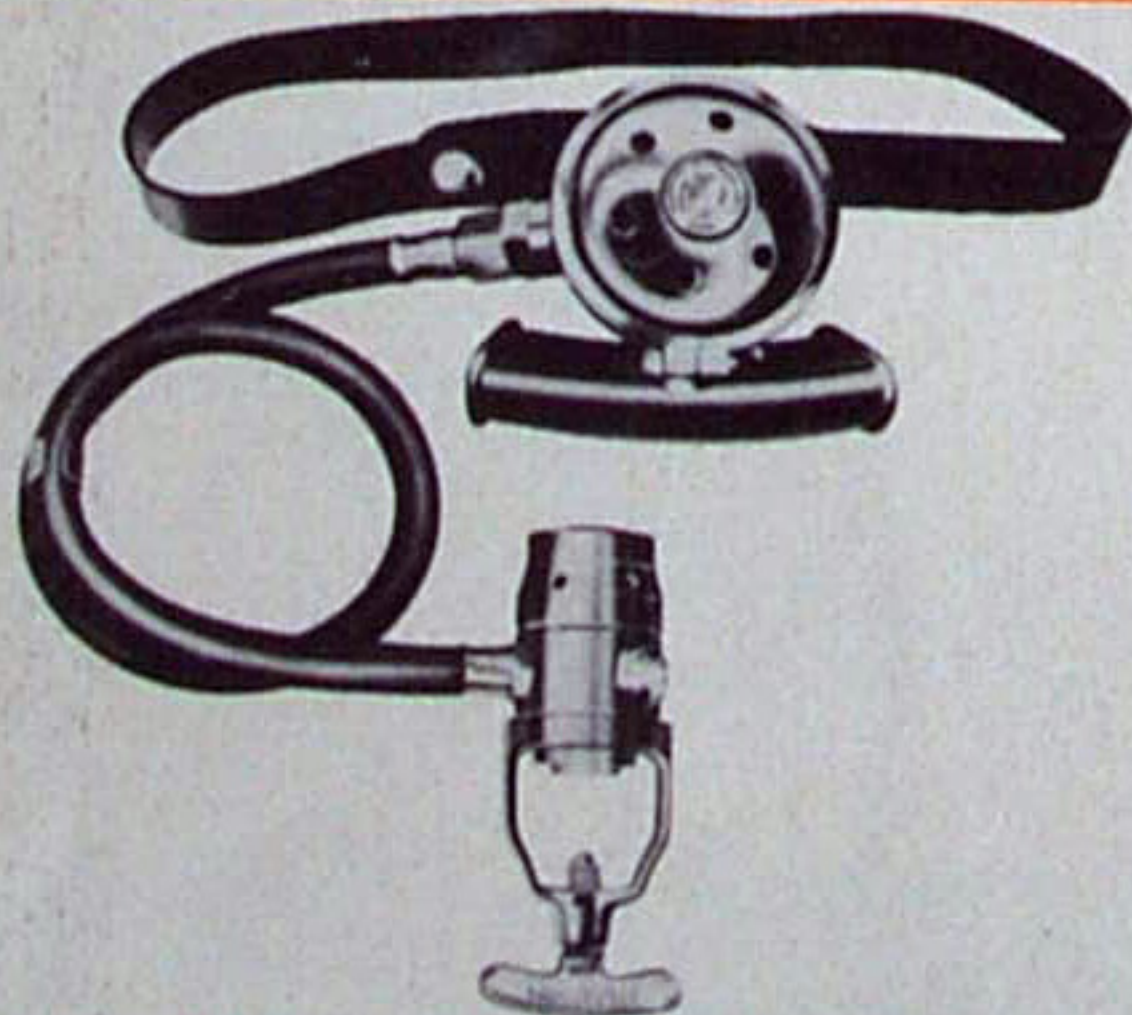

## ORCA

Orca Regulator Packaged in Regulator Carrying Bag

A standby regulator by SPORTSWAYS . . . Designed to meet our highest quality standards.

Pre-set "piston type" first stage, reliable and simple

SPORTSWAYS "downstream valve" made of stainless steel in second stage.

1395 "Orca" Waterlung Regulator.....	\$52.00
1396 "Orca" Waterlung with Sea-View Gauge.....	75.00

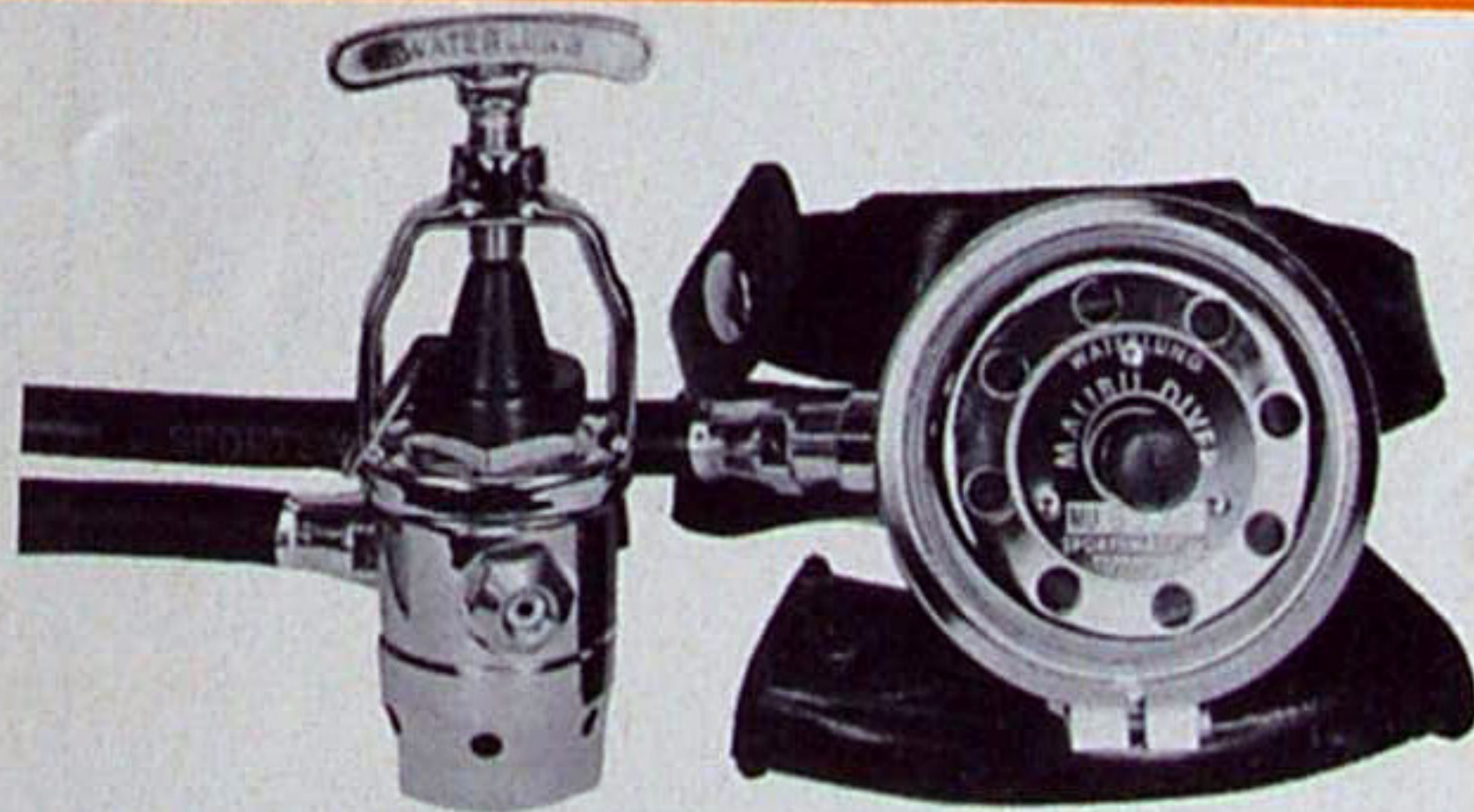

## MALIBU DIVER

Malibu Regulator Packaged in Regulator Carrying Bag

### Outstanding Features:

Fine performance and workmanship at an economy price.

Pre-set "piston-type" first stage, reliable and simple.

EZ breathe rocker valve assembly in second stage.

1330 "Malibu Diver" Waterlung Regulator.....	\$45.00
1331 "Malibu Diver" with Sea-View Gauge.....	69.00



# TANKS

ALL SPORTSWAYS tanks feature the 3/4" opening with "O" ring seal straight thread. The only system that meets military specifications for pressure seals. (MIL-P-5514). When the tank is empty the valve can be easily removed for visual inspection without special tools. SPORTSWAYS valves have exclusive "Safety Port" that vents off pressure and provides warning, preventing accidental removal when there is pressure in the tank. All tanks galvanized, and orange exterior.



Also available,  
Yellow and Black



- 1002 Bare Tank, 71.2 cu. ft. Orange ..... \$ 55.00
- 1013-01 "SJ" Valve Single Tank Assembly. 71.2 cu. ft., Galv., Less Pac ..... 80.00
- 1014-01 "SJ" Valve Single Tank Assembly. 71.2 cu. ft., Orange, Less Pac ..... 85.00

- 1016 "SJ2" Valve Double Tank Assembly. 71.2 cu. ft. Galv. w/Contour-Pac ..... 175.00
- 1017 "SJ2" Valve Double Tank Assembly. 71.2 cu. ft. Orange w/Contour-Pac ..... 185.00
- 1018 "SK2" Valve Double Tank Assembly. 71.2 cu. ft., Galv. w/Contour-Pac ..... 156.00

- 1001 Bare Tank, 71.2 cu. ft., Galv. 50.00
- 1011-01 "SK" Valve Single Tank Assembly. 71.2 cu. ft. Galv. Less Pac ..... 60.00
- 1012-01 "SK" Valve and Tank. 71.2 cu. ft. Orange, Less Pac ..... 65.00
- 1116 Pull Rod, SJ Portable, Stainless Steel ..... 1.35
- 1117 Pull Rod, Double Tank, Stainless Steel ..... 1.35
- 1204-22 Pull Rod, Cam-Pac, Stainless Steel ..... 1.35
- 1320-22 Pull Rod, Navy Unit Dbl., Stainless Steel ..... 1.35

# TANK VALVES

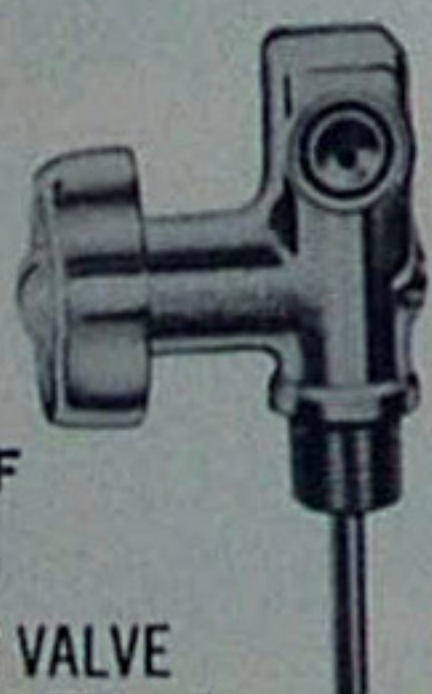

"SK" SHUT-OFF VALVE

- 1115 "SK" TANK VALVE 3/4" Straight Thread ..... \$12.00

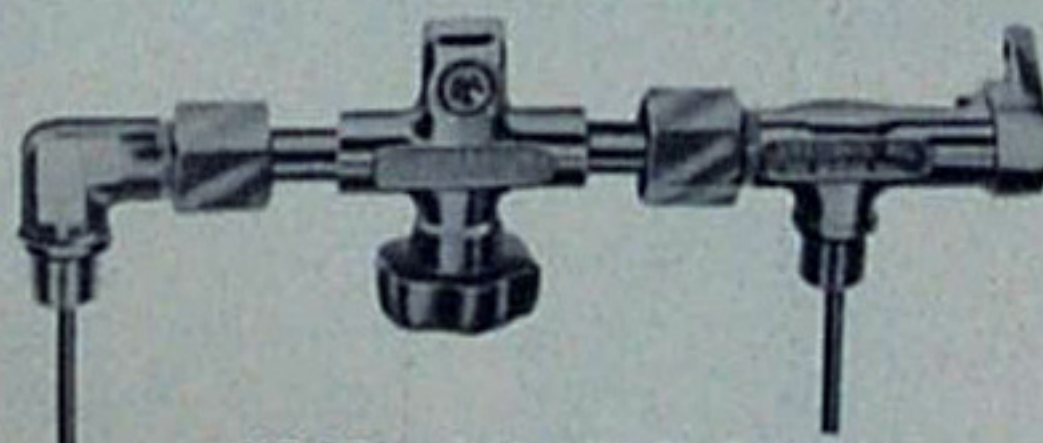

"SJ2" DOUBLE TANK MANIFOLD

- 1103 "SJ2" DOUBLE TANK SPRING-LOADED CONSTANT RESERVE MANIFOLD (500 PSI) 1/2" Std. Pipe Thread ..... \$55.00



"SK2" DOUBLE TANK MANIFOLD

- 1120 "SK2" DOUBLE TANK MANIFOLD. 1/2" Standard Pipe Thread ..... \$39.00
- 1121 "SK2" DOUBLE TANK MANIFOLD. 3/4" Straight Thread ..... \$39.00



"SJ" CONSTANT RESERVE VALVE

- 1102 "SJ" SPRING-LOADED CONSTANT RESERVE VALVE (300 PSI) 1/2" Std. Pipe Thread ..... \$32.00
- 1112 "SJ" SPRING-LOADED CONSTANT RESERVE VALVE (300 PSI) 3/4" Straight Thread ..... \$32.00

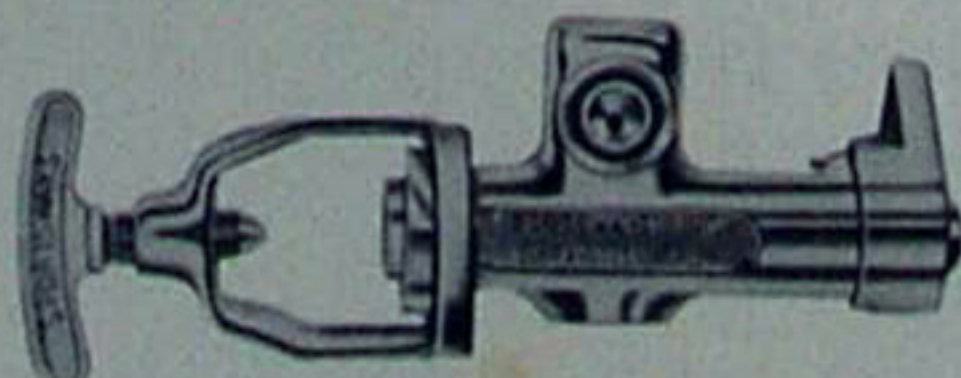

RESERVE VALVE

- 1101 "SJ" Demountable Portable Spring-Loaded Constant Reserve  
Retail: \$20.00

## PARTS LIST

- 1103-01 "SJ2" Reserve Valve for Double Tank Manifold 1/2" Standard Pipe Thread ..... \$24.00
- 1103-02 "SJ2" Double Tank Yoke with "O" Ring Seal ..... 22.00
- 1103-40 "SJ2" Elbow for Double Tank Manifold 1/2" ..... 7.00
- 1113-01 "SJ2" Reserve Tank Valve for Double Tank Manifold 3/4" Straight Thread ..... 24.00
- 1113-40 Elbow for Double Tank Manifold 3/4" ..... 7.00



# TANK PACKS



- 1207 CAM-PAC II  
orange harness .....\$23.00
- 1211 CAM-PAC II—  
gray harness .....\$23.00

**TANK PACKS**  
SPORTSWAYS EXCLUSIVE  
CAM-ACTION RELEASE PERMITS  
MOUNTING ON OR REMOVAL FROM  
TANK IN SECONDS

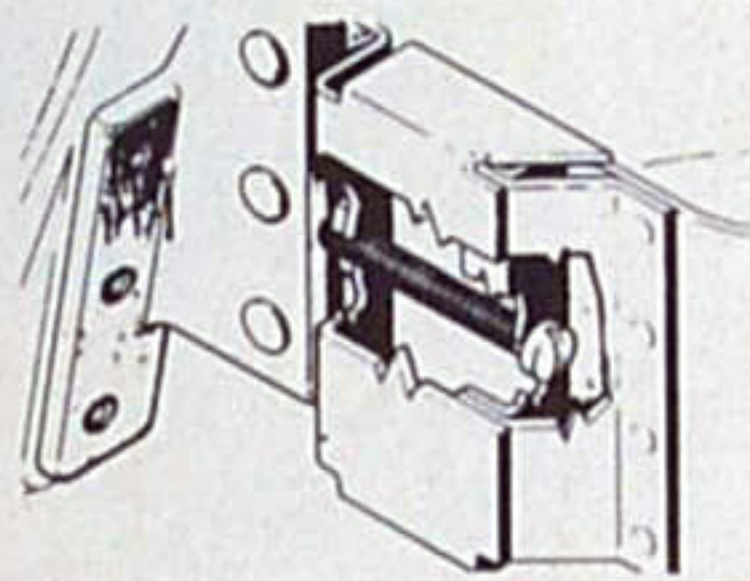

**NON-SLIP SCREW ADJUSTMENT**  
Safety feature designed by Sportsways and featured on the Cam-Pac II. Screw adjustment allows easy tightening of the tank band to prevent possible tank slippage. All component parts are made of stainless steel for maximum durability.



**QUICK RELEASE ASSEMBLY**  
**CONTOUR-PACS**

Sportsways Contour-Pacs feature all the comforts and durability of the Cam-Pac II without the cam-action. The metal tank band adjusts for position and tightness by a single galvanized bolt. Harness is orange or gray nylon webbing for strength and rapid drying. Quick release D-ring assemblies throughout.

- 1205 CONTOUR-PAC— orange harness  
(for single tank assembly) .....\$16.00
- 1209 CONTOUR-PAC—gray harness  
(for single tank assembly) .....\$16.00
- 1206 CONTOUR-PAC—orange harness  
(for double tank assembly) .....\$21.00
- 1213 CONTOUR-PAC—gray harness  
(for double tank assembly) .....\$21.00

# GAUGES



**"SEA-VUE"  
GAUGE**

The "Sea-Vue" Gauge is the most vital instrument ever designed for safety in diving. The equivalent of a fuel gauge in airplanes.

- Accurately indicates your remaining air supply at all-times.
- Allows you to plan your dive minute-to-minute.
- No need to demount regulator to check tank pressure.
- Waterproof, pressure proof construction with "O"-ring seals.
- Luminous dial.
- Chrome-plated Navy brass case and bezel.
- Stainless steel braided hose encased in neoprene.
- Each hose tested at 6,000 P.S.I.

1401 SEA-VUE Pressure Gauge \$24.00

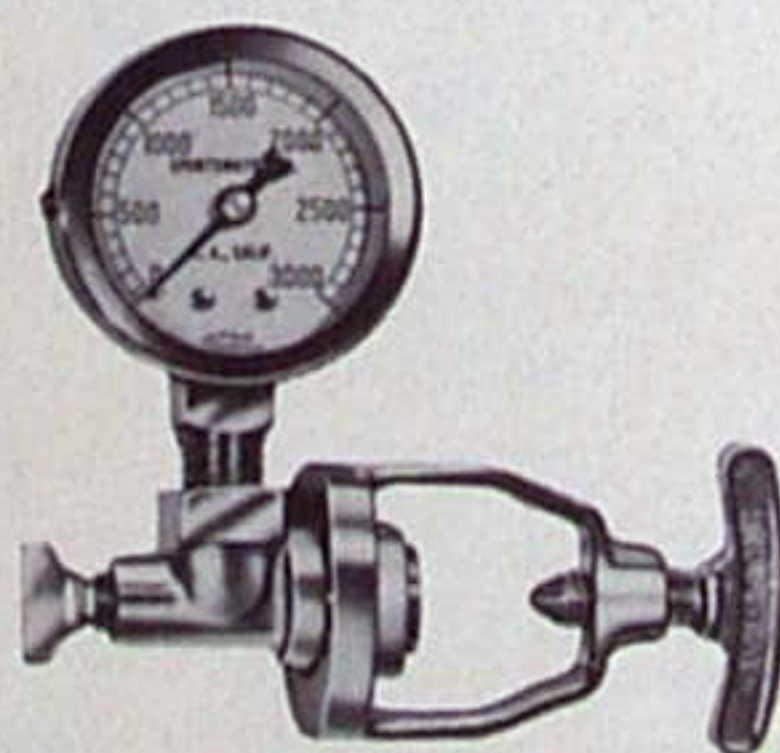

**TANK PRESSURE GAUGE &  
YOKE WITH  
BLEEDER VALVE**

Brass case. Main body with bleeder valve—brass forging. Large brass forging thumb screw, easy to bleed. All chrome plated.

- 1403 Tank Pressure Gauge  
and Yoke with Bleeder  
Valve .....\$13.00
- 1403-01 Bleeder Valve Thumb  
Screw ..... 1.50



**WATERLUNG DEPTH GAUGE**

Completely new original Sportsways design. Engineered for complete reliability in two ranges. The most accurate and durable in the underwater field.

- High impact Cyclocac case for maximum durability.
- "O"-ring seal gauge cap for complete pressure proof seal.
- Luminous markings and indicator for easy reading.
- Exclusive mechanism design that permits removal for factory inspection and setting.

- 1410 Waterlung Depth Gauge  
250 ft. ....\$10.00
- 1411 Waterlung Depth Gauge  
150 ft. ....\$10.00



# WATERLUNG FINS

The WATERLUNG FINS incorporate all the requirements necessary for maximum utility — comfort — power — efficiency — durability.

This exclusive design features:

★ Full foot with high cut heel design for complete protection in or out of the water.

★ Specially contoured foot pockets provide unequaled comfort and perfect fit in all sizes.

★ Added blade length in both Regular and Giant sizes.

★ Tapered extra high external ribs for added power.

★ Ideal for use with or without boots. Available in Jet Black or Floating Blue



Jet Black

Floating Blue

Cat. No.	Size	Color	Price
1512	Reg., 4-5	Black	\$ 9.00
1513	Reg., 5½-6½	Black	\$10.00
1514	Reg., 7-8	Black	\$10.00
1515	Reg., 8½-9½	Black	\$11.00
1516	Reg., 10-11	Black	\$12.00
1517	Giant, 11½-13	Black	\$13.00
1518	Giant, 13½-16	Black	\$15.00

Cat. No.	Size	Color	Price
1522	Reg., 4-5	Blue	\$10.00
1523	Reg., 5½-6½	Blue	\$11.00
1524	Reg., 7-8	Blue	\$11.00
1525	Reg., 8½-9½	Blue	\$12.00
1526	Reg., 10-11	Blue	\$13.00
1527	Giant, 11½-13	Blue	\$14.00
1528	Giant, 13½-16	Blue	\$16.00

Specially contoured foot pockets provide unequaled comfort and perfect fit in all sizes.

Full foot with high cut heel design for complete protection in or out of the water.

Tapered extra high external ribs for added power.

Added blade length in both Regular and Giant sizes.

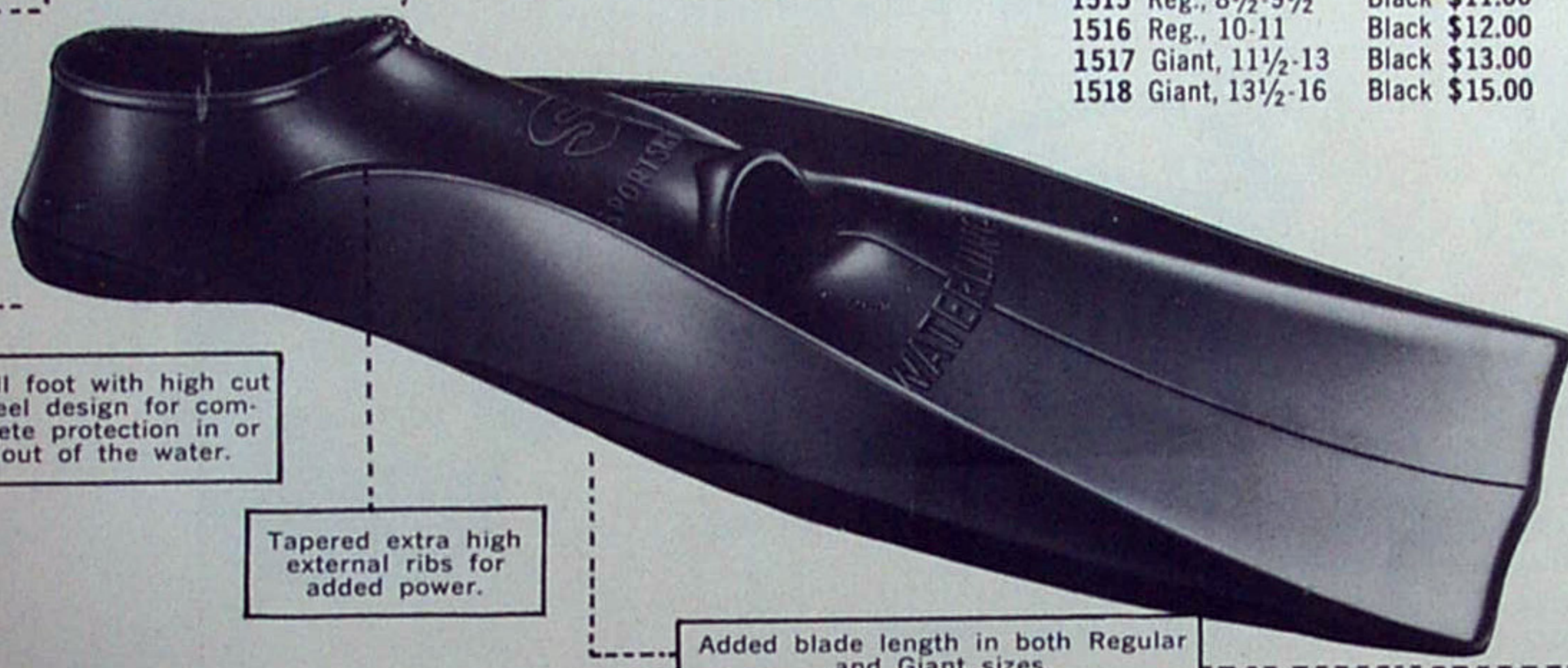

# ORCA FINS

The world's most powerful fins. ORCA FINS are unequaled for thrust, speed and comfort. Hydrodynamic design combines symmetry and rugged construction for maximum propulsion.

- Resilient compound for maximum wear and durability.
- Snug-fit contoured foot pocket ideal for use with or without boots.

- Extra long fin blade for added power.
- All edges and heel straps contoured, eliminating chafing, cramps and fatigue.
- Heavy, symmetrically tapered ribs for maximum power.
- Exclusive instep design provides unrivaled comfort and full instep contact for complete power transfer.

1565	Giant, Medium Large	Shoe Size 9½-10½	Gum	\$15.00
1566	Giant, Large	Shoe Size 11-13	Gum	\$15.00
1567	Giant, Extra Large	Shoe Size 13-14	Gum	\$15.00
1568	Giant, Super Extra Large	Shoe Size 14-16	Gum	\$16.00

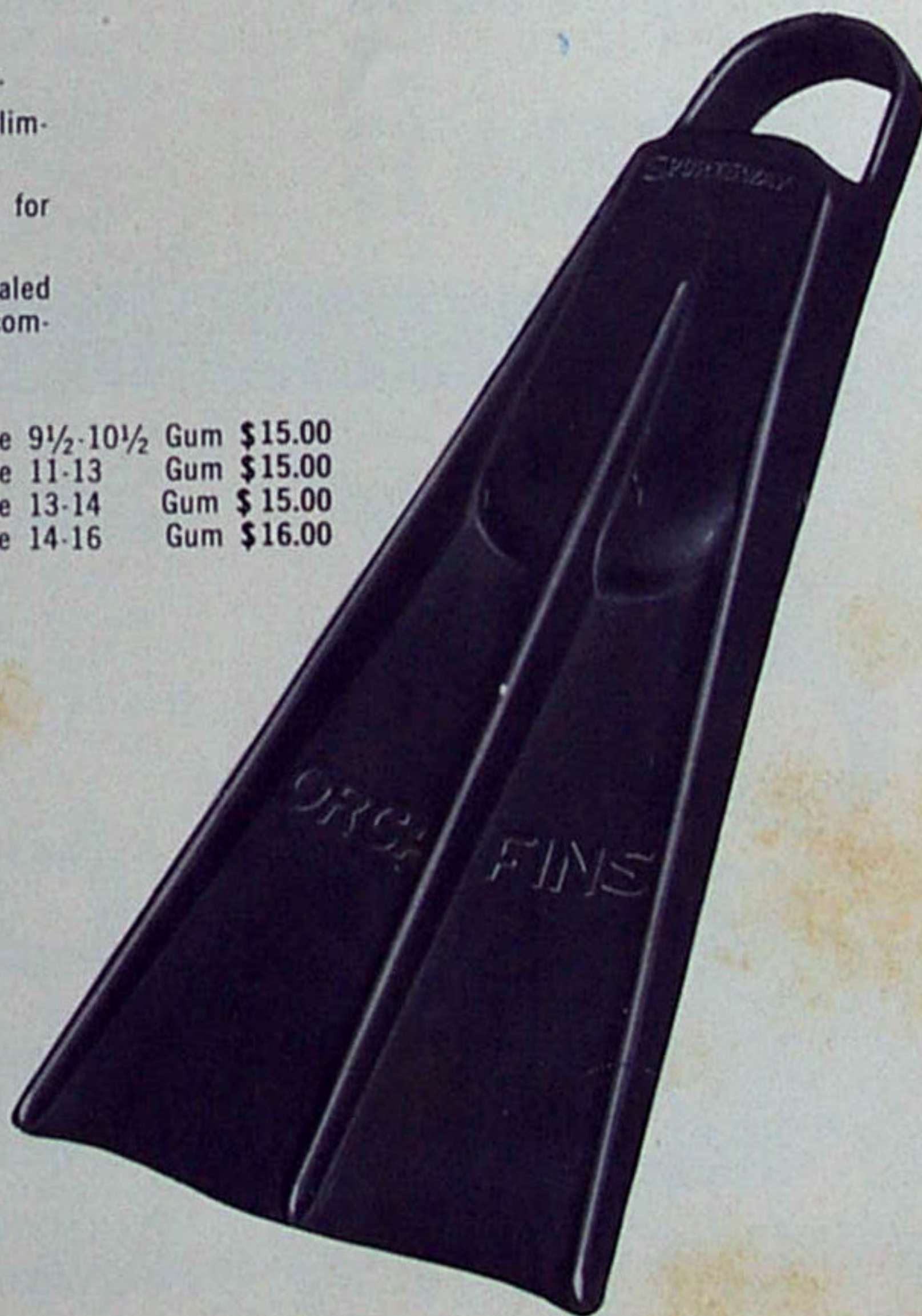
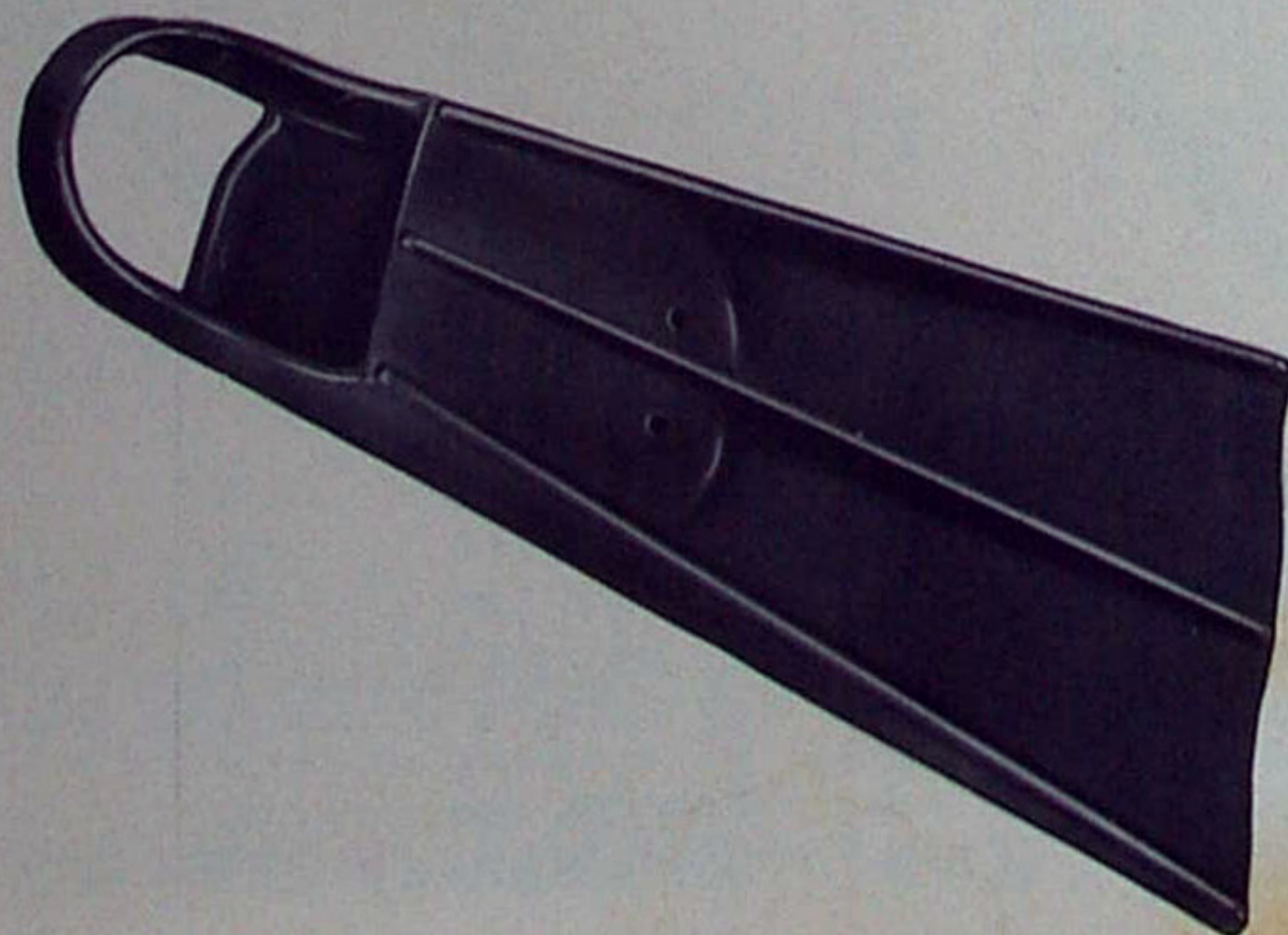



# MASKS



## "WATERLUNG" MASK

MADE BY CRAFTSMEN FOR EXPERTS

- ★ High efficiency, non-return exhaust valve for instant clearing, largest possible orifice.
- ★ Close-to-the-face design for increased vision and minimum displacement.
- ★ Flat grid exhalation port provides easier equalization.
- ★ Lens design provides 30% more visibility. Tempered safety glass lens.
- ★ Comfortable split head strap, adjustable from both sides for secure seal.
- ★ Hinged head strap buckles adds greater life to head strap.
- ★ Extruded foam neoprene sealing edge for a perfect seal and comfort.
- ★ Deluxe heavy duty mask bands.

- 1626 Waterlung mask with black anodized bands .....\$13.50
- 1626-4 Band replacement kit for Waterlung Mask black anodized top and bottom bands, 2 band screws ..... 2.75



## "VISTA-VUE" MASK

Slanted lens design provides better viewing. Shorter top skirt aids sealing during ascent. Stainless steel rim and screw adjustment locks lens in safe position. Tempered safety glass lens, high quality blue rubber compound or black neoprene.

- 1650 "VISTA-VUE"  
French blue .....\$4.95
- 1651 "VISTA-VUE"  
Black neoprene .....\$4.95



## "EQUALIZER" MASK

Slanted lens "Vista-Vue" design with easy-grip equalizing feature. Deep-set easy-to-reach, double step recessions permit quick pressure relief without breaking face-mask seal. An exclusive Sportsways design.

- 1652 "EQUALIZER" MASK  
French Blue .....\$5.95
- 1653 "EQUALIZER" MASK  
Black neoprene .....\$5.95



## "EQUALIZER PURGE"

- 1628 "EQUALIZER PURGE" MASK  
with purge valve, black  
neoprene .....\$6.95

# SNORKELS

## "WATERLUNG" SNORKEL



The most efficient and comfortable snorkel ever developed. Flexible hose design provides complete freedom when inserting or removing mouthpiece. No twisting or pulling. Drops out of the way when not in use. New mouthpiece design has all edges contoured for complete comfort.

- 1620 Waterlung Snorkel — International Orange Tube .....\$3.00
- 1621 Waterlung Snorkel—Jet Black Tube .....\$3.00

## "COMPETITOR" SNORKEL

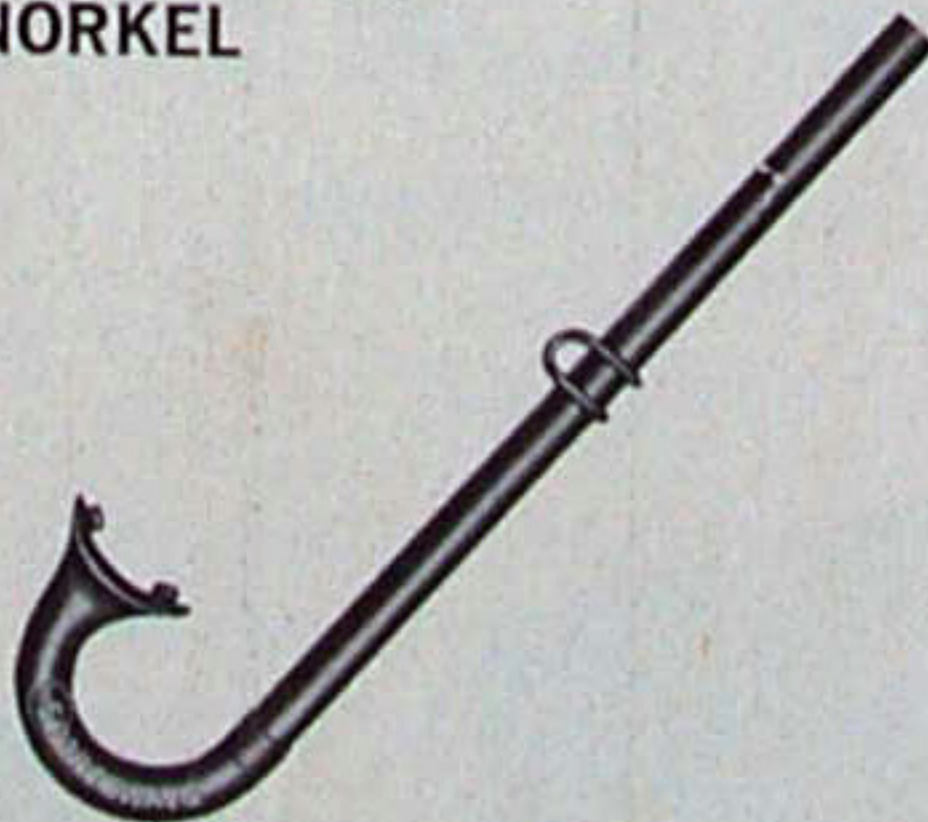

The only snorkel in the field constructed of neoprene . . . designed to provide sufficient volume of air under all conditions. One piece moulded elbow allows quick, easy clearing. The Competitor answers the need for an expert snorkel.

- 1614 Competitor Snorkel .....\$2.50

## "CATALINA" SNORKEL

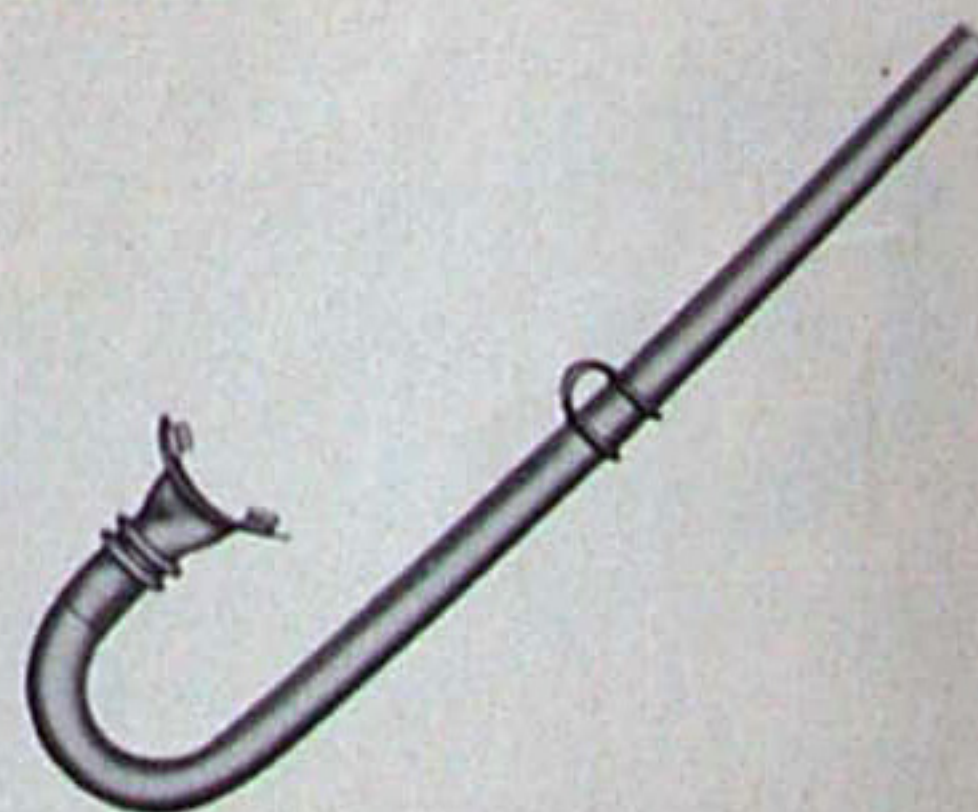

The "Catalina" is designed for the pro diver. The "Catalina" is constructed of the finest black rubber and equipped with bellows mouthpiece.

- 1623 Catalina Snorkel .....\$2.00



# SUITS & SUIT ACCESSORIES

Only through constant research has Sportsways been successful in bringing to you the suits, ski jackets, surf suits, surf vests, hard soled boots, contoured hoods, five fingered dexterity gloves, and three fingered mitts.

1966 Sportsways underwater exposure suits made of durable nylon-lined TUFKIN, 3-piece, 5 Heavy-duty zippers, form fit, under-arm bulging eliminated to a minimum, all seams sewn at stress points, 3/16" and 1/4", available in five sizes.

## SIZE CHART FOR SPORTSWAYS SUITS

	Extra Small	Small	Medium	Large	Extra Large
CHEST	31" - 33"	34" - 36"	37" - 39"	40" - 42"	43" - 46"
WAIST	24" - 26"	27" - 29"	30" - 32"	33" - 35"	36" - 38"
HEIGHT	5'2" - 5'7"	5'5" - 5'9"	5'7" - 6'0"	5'10" - 6'2"	6'0" - 6'4"

### SUITS:

3/16"	Cat. No.	Size	Retail	1/4"	Cat. No.	Size	Retail
}	5030	Extra-Small	\$68.00	}	5040	Extra-Small	\$72.00
	5031	Small	68.00		5041	Small	72.00
	5032	Medium	68.00		5042	Medium	72.00
	5033	Large	68.00		5043	Large	72.00
	5034	Extra-Large	68.00		5044	Extra-Large	72.00



### SUIT JACKET:

3/16"	Cat. No.	Size	Retail	1/4"	Cat. No.	Size	Retail
}	5030-1	Extra-Small	\$42.00	}	5040-1	Extra-Small	\$46.00
	5031-1	Small	42.00		5041-1	Small	46.00
	5032-1	Medium	42.00		5042-1	Medium	46.00
	5033-1	Large	42.00		5043-1	Large	46.00
	5034-1	Extra-Large	42.00		5044-1	Extra-Large	46.00

### SUIT PANTS:

3/16"	Cat. No.	Size	Retail	1/4"	Cat. No.	Size	Retail
}	5030-2	Extra-Small	\$35.00	}	5040-2	Extra-Small	\$37.00
	5031-2	Small	35.00		5041-2	Small	37.00
	5032-2	Medium	35.00		5042-2	Medium	37.00
	5033-2	Large	35.00		5043-2	Large	37.00
	5034-2	Extra-Large	35.00		5044-2	Extra-Large	37.00



### HOODS:

TUFKIN Nylon-Lined, seams sewn at stress points, contoured in such a manner that a near perfect seal around the entire face and neck is assured. 3/16" and 1/4", available in five sizes.

3/16"	Cat. No.	Size	Retail	1/4"	Cat. No.	Size	Retail
}	5030-3	Extra-Small	\$5.00	}	5040-3	Extra-Small	\$5.60
	5031-3	Small	5.00		5041-3	Small	5.60
	5032-3	Medium	5.00		5042-3	Medium	5.60
	5033-3	Large	5.00		5043-3	Large	5.60
	5034-3	Extra-Large	5.00		5044-3	Extra-Large	5.60

### BOOTS:

TUFKIN Nylon-Lined, Hard-sole, zippered boots, all seams sewn at the vital stress points. 3/16" and 1/4", available in seven sizes.

3/16"	Cat. No.	Size	Retail	1/4"	Cat. No.	Size	Retail
}	5030-4	Extra-Small (5-6)	\$10.00	}	5040-4	Extra-Small (5-6)	\$11.00
	5031-4	Small (7-8)	10.00		5041-4	Small (7-8)	11.00
	5032-4	Medium (8-9)	10.00		5042-4	Medium (8-9)	11.00
	5033-4	Medium-Large (9-10)	10.00		5043-4	Medium-Large (9-10)	11.00
	5034-4	Large (10-11)	10.00		5044-4	Large (10-11)	11.00
	5035-4	Extra-Large (11-13)	10.00		5045-4	Extra-Large (11-13)	11.00
	5036-4	Super X-Large (13-15)	10.00		5046-4	Super X-Large (13-15)	11.00







## MITTS:

TUFSKIN Nylon-Lined, three fingered, designed to our exacting demands. 3/16" available in five sizes.

Cat. No.	Size	Retail
5030-5	Extra-Small	\$6.25
5031-5	Small	6.25
5032-5	Medium	6.25
5033-5	Large	6.25
5034-5	Extra-Large	6.25



## GLOVES:

TUFSKIN, Nylon-Lined, five fingered glove, manufactured to our exacting demands to create the finger dexterity so vitally necessary for the expert diver. 3/16", available in five sizes.

Cat. No.	Size	Retail
5030-6	Extra-Small	\$7.50
5031-6	Small	7.50
5032-6	Medium	7.50
5033-6	Large	7.50
5034-6	Extra-Large	7.50



## SKI JACKET:

TUFSKIN Nylon-Lined short sleeves, with beaver tail, 3/16" and 1/8", available in five sizes.

3/16"	Cat. No.	Size	Retail
}	5530	Extra-Small	\$23.75
	5531	Small	23.75
	5532	Medium	23.75
	5533	Large	23.75
	5534	Extra-Large	23.75

1/8"	Cat. No.	Size	Retail
}	5520	Extra-Small	\$22.50
	5521	Small	22.50
	5522	Medium	22.50
	5523	Large	22.50
	5524	Extra-Large	22.50



## SHORTY SURF & SKI SUIT

TUFSKIN, Nylon-lined, short sleeves, short legs, 3/16", available in five sizes.

Cat. No.	Size	Retail
5630	Extra-Small	\$32.50
5631	Small	32.50
5632	Medium	32.50
5633	Large	32.50
5634	Extra-Large	32.50

**VEST:** TUFSKIN, Nylon Lined, no arms, no beaver tail, no zippers, 3/16" and 1/8", available in five sizes.

3/16"	Cat. No.	Size	Retail	1/8"	Cat. No.	Size	Retail
}	5730	Extra-Small	\$16.00	}	5720	Extra-Small	\$15.00
	5731	Small	16.00		5721	Small	15.00
	5732	Medium	16.00		5722	Medium	15.00
	5733	Large	16.00		5723	Large	15.00
	5734	Extra-Large	16.00		5724	Extra-Large	15.00

**SKI VEST:** TUFSKIN, Nylon-lined, with zipper, no arms, no beaver tail, 3/16" and 1/8", available in five sizes.

3/16"	Cat. No.	Size	Retail	1/8"	Cat. No.	Size	Retail
}	5830	Extra-Small	\$20.00	}	5820	Extra-Small	\$18.75
	5831	Small	20.00		5821	Small	18.75
	5832	Medium	20.00		5822	Medium	18.75
	5833	Large	20.00		5823	Large	18.75
	5834	Extra-Large	20.00		5824	Extra-Large	18.75





## PRODUCTION BOARDS — "LANI-KAI" OR "KEOKI"

### SPECIFICATIONS:

Mat Blank, 10 oz. Volan Fiberglass, Cloth Overlapped Rails, Stringers Top and Bottom, Laminated Wood Skeg, with Fiberglass Halo. All Standard Colors Taped off Top and Bottom. Featuring Polished Rails.

Cat. No.	Size	Retail
4010	8'6"	124.50
4014	8'10"	126.00
4016	9'	128.00
4018	9'2"	130.00
4020	9'4"	130.00
4022	9'6"	132.50
4024	9'8"	132.50
4028	10'	134.00

## CUSTOM BOARDS — "LANI-KAI" OR "KEOKI" Labels

### SPECIFICATIONS:

Highest Quality Shaping Foam Blanks, Routed, Trussed Redwood or Balsa Stringers, 2 layers 10 oz. Silene Fiberglass Overlapped on Rails, Laminated Wood Skeg with Fiberglass Halo. All Available Colors.

Cat. No.	Size	Retail
4220	9'4"	148.95
4222	9'6"	150.00
4224	9'8"	150.00

## SUGGESTED WEIGHT SCHEDULE

Under 100 lbs.	8'7"
Under 120 lbs.	9'0"
Under 140 lbs.	9'2"
Under 160 lbs.	9'4"

Under 165 lbs.	9'6"
Under 180 lbs.	9'8"
Under 200 lbs.	10'0"
Over 200 lbs.	11'0"



## SURFING TRUNKS

Travis Ruggednyl, 100% Nylon.  
Nylon Thread.

Velcro Front Flap Closure, Reinforced Inside Button.

Wallet Size Pocket with Velcro Closure.

### COLORS:

Navy - Powder Blue - Gold - Brown - Maroon - Orange - Green - Rust - Red - Royal Blue — All With Contrasting Competitive Stripes.

Cat. No.	Size
722-26	26
722-28	28
722-30	30
722-32	32
722-34	34
722-36	36
722-38	38

## SURFER JACKETS

Travis Ruggednyl, 100% Nylon.

Nylon Thread.

Nickel Plated Brass Zipper, Won't Rust.

Nickel Plated Grommets.

### SIZES:

Small - Medium - Large.

### COLORS:

Same as Trunks.

Cat. No.	Size
723-1	Small
723-2	Medium
723-3	Large

## SKIN DIVERS JACKET



**SIZES:**  
Small  
Medium  
Large

Cat. No.	Size
723A-1	Small
723A-2	Medium
723A-3	Large

**COLOR:**  
Brilliant Red w/White Stripe.

## STORMY WEATHER SUITS



IDEAL PROTECTION FROM WIND AND RAIN

- HUNTING
- FISHING
- SKIING
- YACHTING
- HIKING
- RACING
- GOLFING

The STORMY WEATHER Suits offer light weight and complete flexibility at all temperatures. The suits are of the best quality Polyvinyl material with new process welded seams, resistant to oil and grease. Snaps are heavy duty and non-corrosive.

Convenient storage bag included.

### MENS

Cat. No.	Size
724-1	Small
724-2	Medium
724-3	Large

### WOMENS

Cat. No.	Size
724A-1	Small
724A-2	Medium

### COLORS:

International Orange - Yellow - Blue - Olive Green.



# SAFETY VESTS

FIRST IN SAFETY AND QUALITY, THE MOST RELIABLE VEST MADE.

## Exclusive features:

- Rugged material. Nylon impregnated with neoprene. Meets military specifications. Mil-C 19002 Type 1.
- Impervious to salt water, sun, snags. The most durable material ever.
- Sure-fire inflation mechanism.
- Replaceable, fool-proof, screw-in type CO<sub>2</sub> cartridges.
- Leak-proof oral inflation tube with manual shut-off for added safety. Tube can be used to vent off excessive pressure.
- "Center-zip" design eliminates bulk. Easy donning and exit.
- Head is kept out of water.
- Detonator on reverse side eliminates possibility of entanglement.
- Strap design ensures safe, proper positioning.
- All strap tabs DOUBLE reinforced.

You can not compromise on quality when your life depends on a piece of safety equipment . . . buy the vest that has been duplicated but never equalled.

1800	Navy Safety Vest, orange .....	\$26.00
1810	Navy Safety Vest, gray .....	\$26.00
1800-35	Cartridge, 12 gram, CO <sub>2</sub> Screw-in.....	\$ .75
1800-38	Safety Vest Repair Kit, orange .....	\$ 2.50
1810-38	Safety Vest Repair Kit, gray .....	\$ 2.50

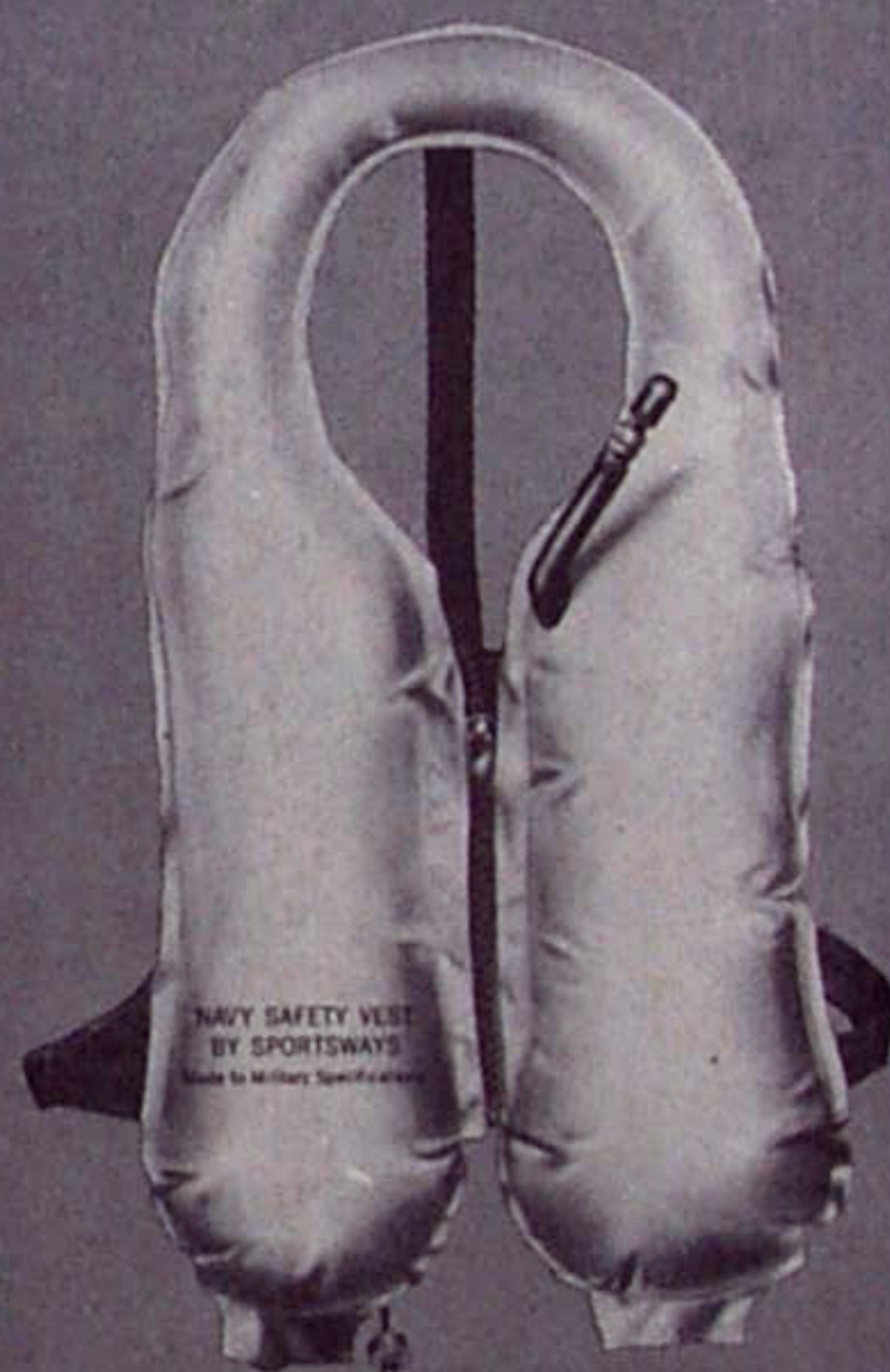

## DIVERS VEST:

The finest life vest available of the "Mae West" Navy design. Complete CO<sub>2</sub> automatic inflation system. Oral valve . . . the "Depress to Inflate" type, helpful in obtaining zero buoyancy. Fine poplin material — fully bound edges. Adjustable waist strap to fit youngsters as well as adults. Can be inflated manually.

Cat. No. 1820 ..... Retail \$15.95

## AUTOMATIC INFLATION FOR LIFE VESTS:

Navy Specifications on Hardware for complete CO<sub>2</sub> automatic inflation system. Screw-in type; replaceable CO<sub>2</sub> cartridge — oversize 12 gram capacity. All hardware protected against salt water corrosion. Just pull Lanyard for instant inflation. Extra CO<sub>2</sub> gas cylinders.

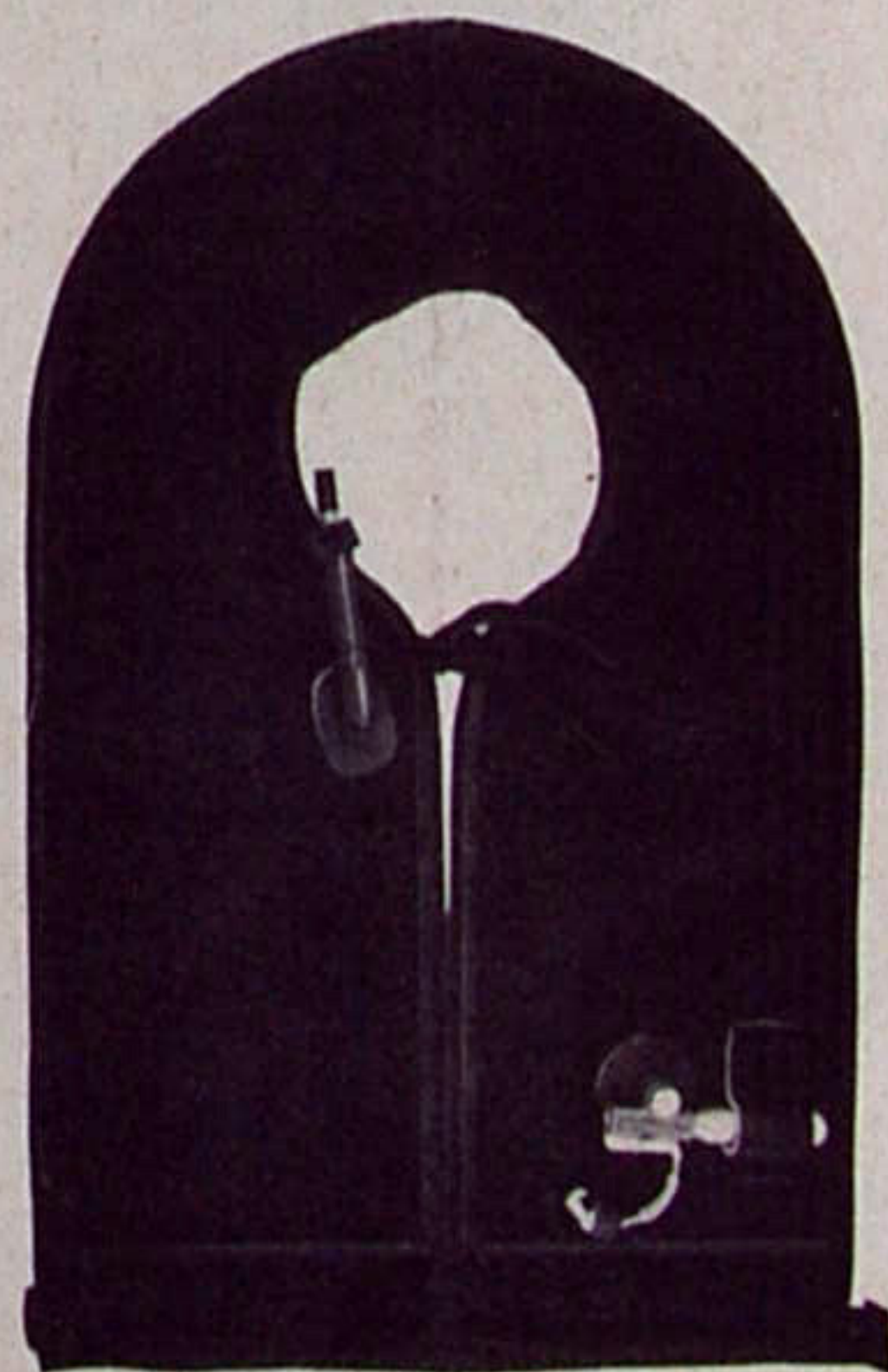



# SPEAR GUNS

The ultimate in spear guns. Developed from exclusive principles for maximum power—unequaled accuracy—complete durability—minimum maintenance. All stainless steel internal parts. Used in competition throughout the world.

- ★ Exclusive trigger release leverage system eliminates trigger pull resistance, no matter how many slings are used.
- ★ High impact Cycloc handles and muzzles eliminates internal corrosion and provides lightness and maneuverability.
- ★ Spear guns float after firing.
- ★ "O"-ring seals in the barrel, the only foolproof seal against water and pressure.
- ★ Cocking stock for balance, accuracy, quicker handling, and easier loading. Also can be used for storage of spear tips.
- ★ Automatic line release eliminates drag and veer. Out of the way of hands.
- ★ Stainless steel shaft with exclusive safety notch that eliminates slipping or accidental firing.
- ★ Fool-proof safety. Stainless steel internal part.

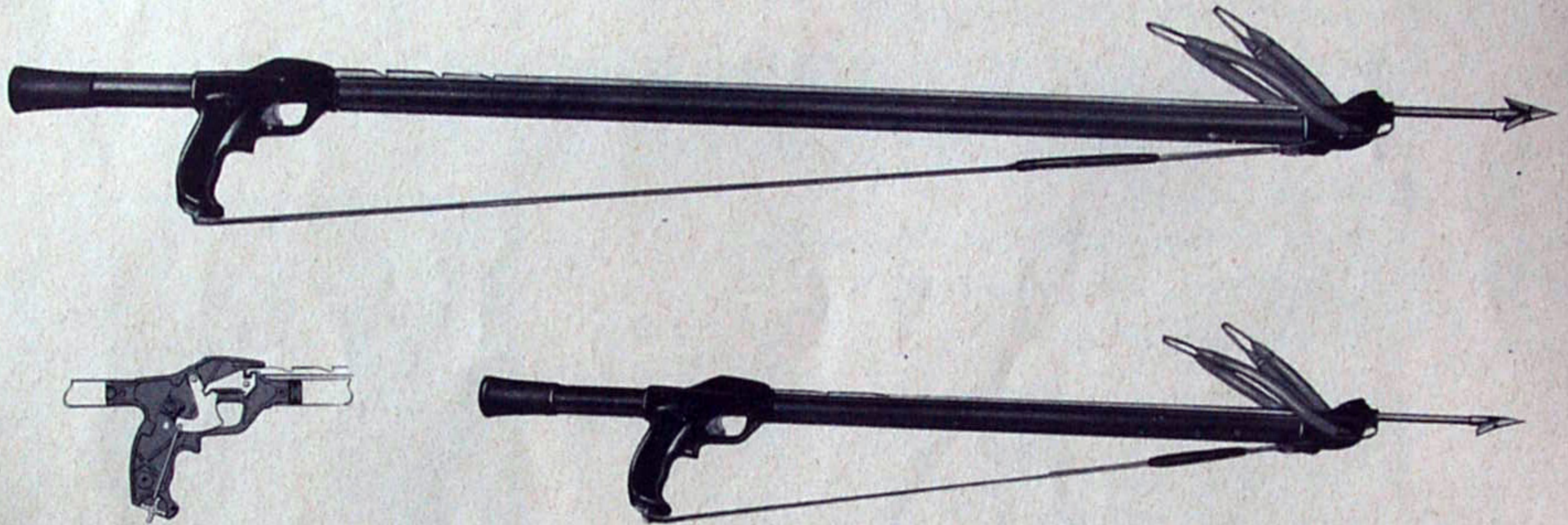

1635	"COMPETITOR" SPEAR GUN with Stainless Steel Two Barb Spearhead .....	\$ 29.00	1636-25	SLING (Short) 13" Sportsman .....	2.25
1635-25	SLING (long) 21" Competitor .....	2.75	1636-28	SHAFT (Short) S.S. Sportsman .....	7.50
1635-28	SHAFT (long) S.S. Competitor .....	8.00	1635-3	MUZZLE .....	1.50
1636	"SPORTSMAN" SPEAR GUN with Stainless Steel Single Barb Spearhead .....	22.00	1635-50	GRIP Complete (assembled) .....	12.95



**SINGLE BARB  
SPEARHEAD**  
Stainless steel  
1636-51      \$1.95

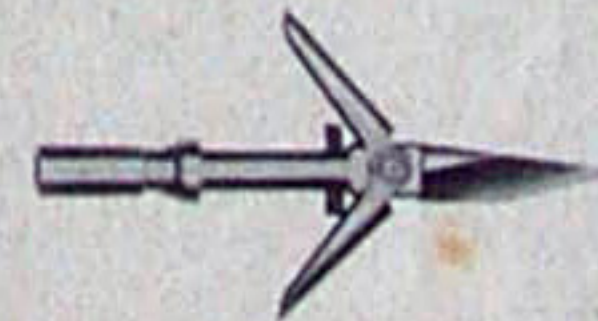

**TWO-BARB  
SPEARHEAD**  
stainless steel,  
retractable  
1635-52      \$3.95



# KNIVES

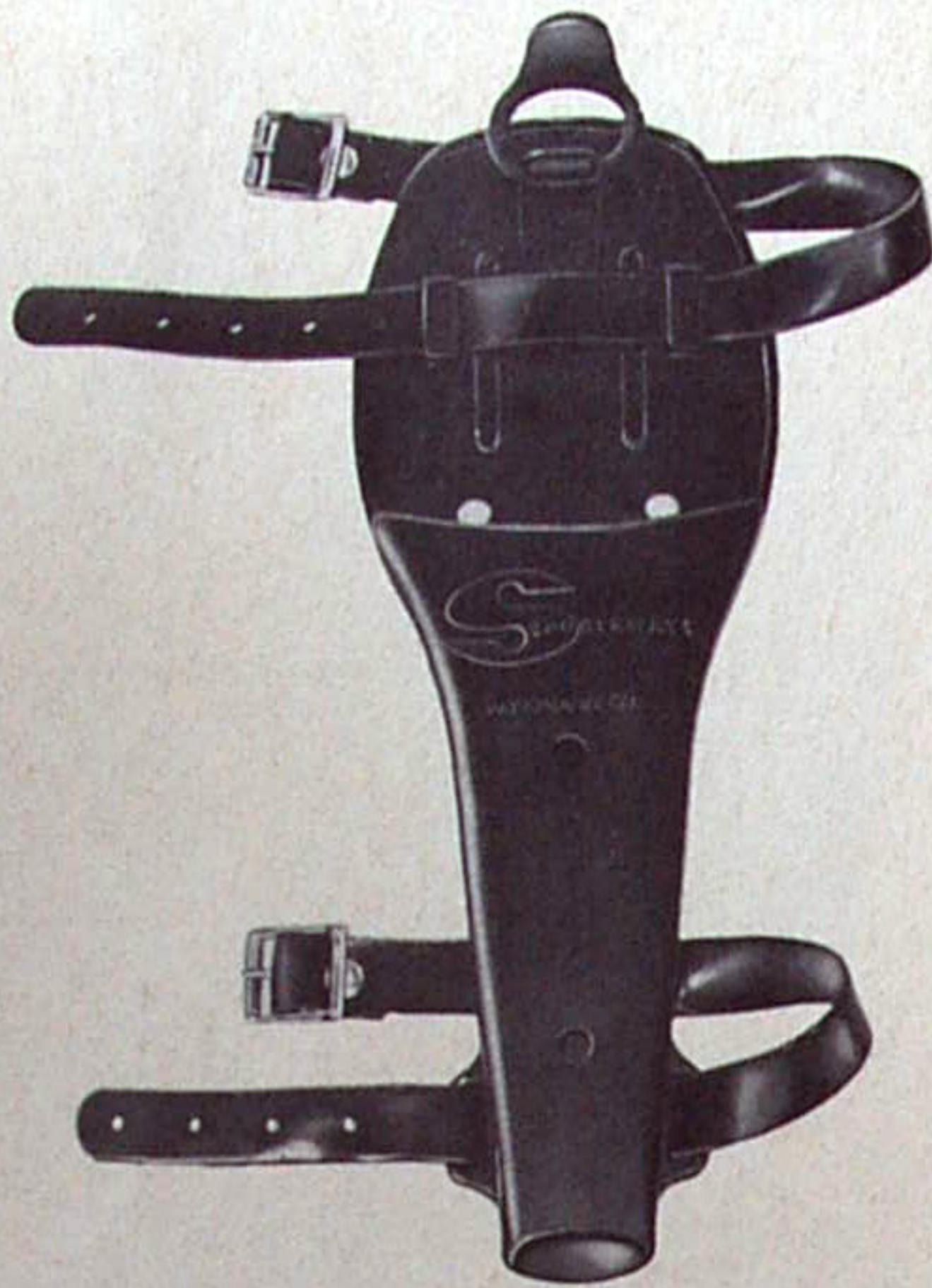

## "NAVY" KNIFE AND SHEATH

- Superb knife to meet all requirements — a sturdy working tool.
- Full-length cutting edge to tapered point, with large serrated area.

1631 Navy Knife (black handle) .....\$10.25  
 1641 Navy Knife (orange handle) .....\$10.25

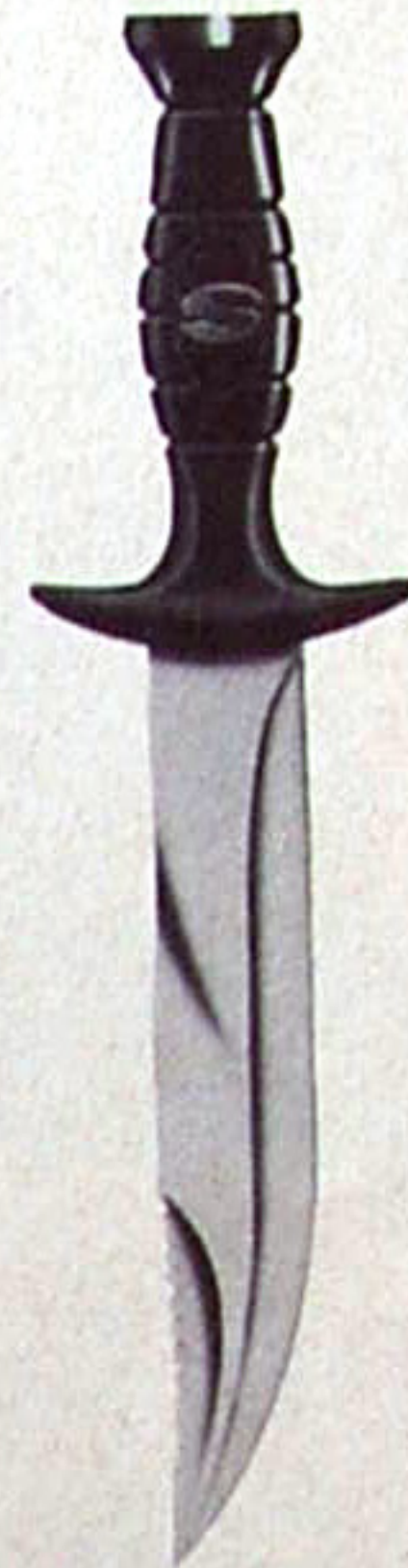

## "DIVER" KNIFE AND SHEATH

- Extremely attractive, completely versatile diver's knife.
- Concave serrated area on opposite edge.

1630 Diver Knife (black handle) .....\$10.25  
 1640 Diver Knife (orange handle) .....\$10.25

# DIVING WATCHES



## CLEBAR WATCH

Sportsways presents new thinking in diving watch design. The first and only underwater timepiece with an internal bezel for ultimate protection! Bezel turns beneath the pressure proof crystal by a bevel-gear knob. Completely automatic, 17 jewel, anti-magnetic, shock-resistant, with stainless steel case. Pressure tested for 20 atmospheres — 660 feet!

1421 WATERLUNG  
 CLEBAR,  
 white  
 dial .... 100.00

1422 WATERLUNG  
 CLEBAR,  
 black  
 dial ....\$100.00



## SEA WOLF DATOGRAPHIC

1750-B      1750-W  
 Black      White  
 \$110.00    \$110.00



LADIES  
 SEA WOLF  
 2036  
 100.00



SEA WOLF  
 3080-B  
 Black dial  
 \$100.00  
 3080-W  
 White dial  
 \$100.00

## EXPANSION BRACELET

Smartly designed, rust-proof stainless steel for long life under rugged conditions. Satin finish.

3080-2 Expansion Bracelet,  
 stainless steel .....\$9.95



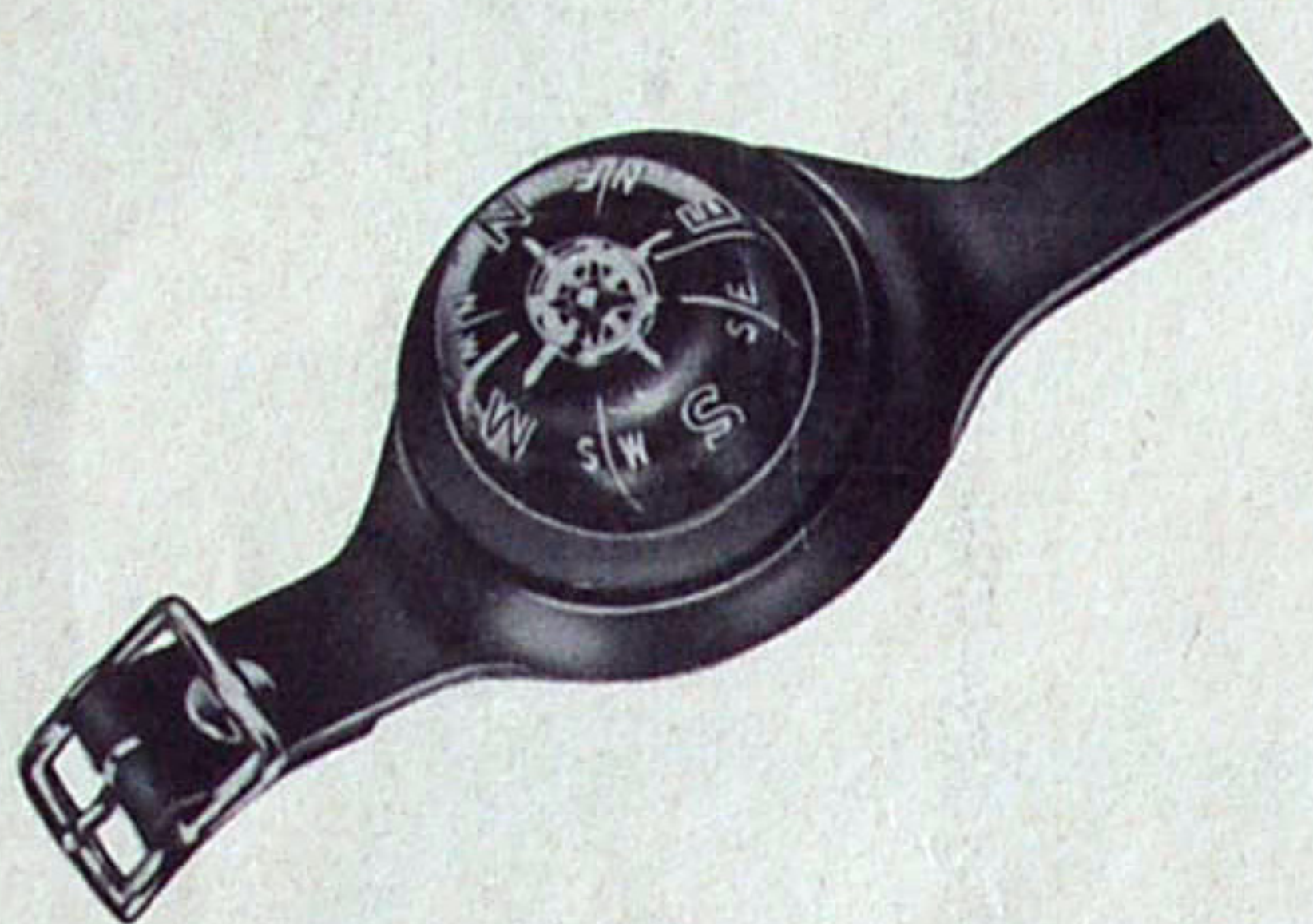

**UNDERWATER COMPASS**

Completely accurate and easy to read. Design features revolving dome compass for stability. Liquid Filled. Durable jet black rubber case and strap.

1420 Sportsways Underwater Compass .....\$3.95

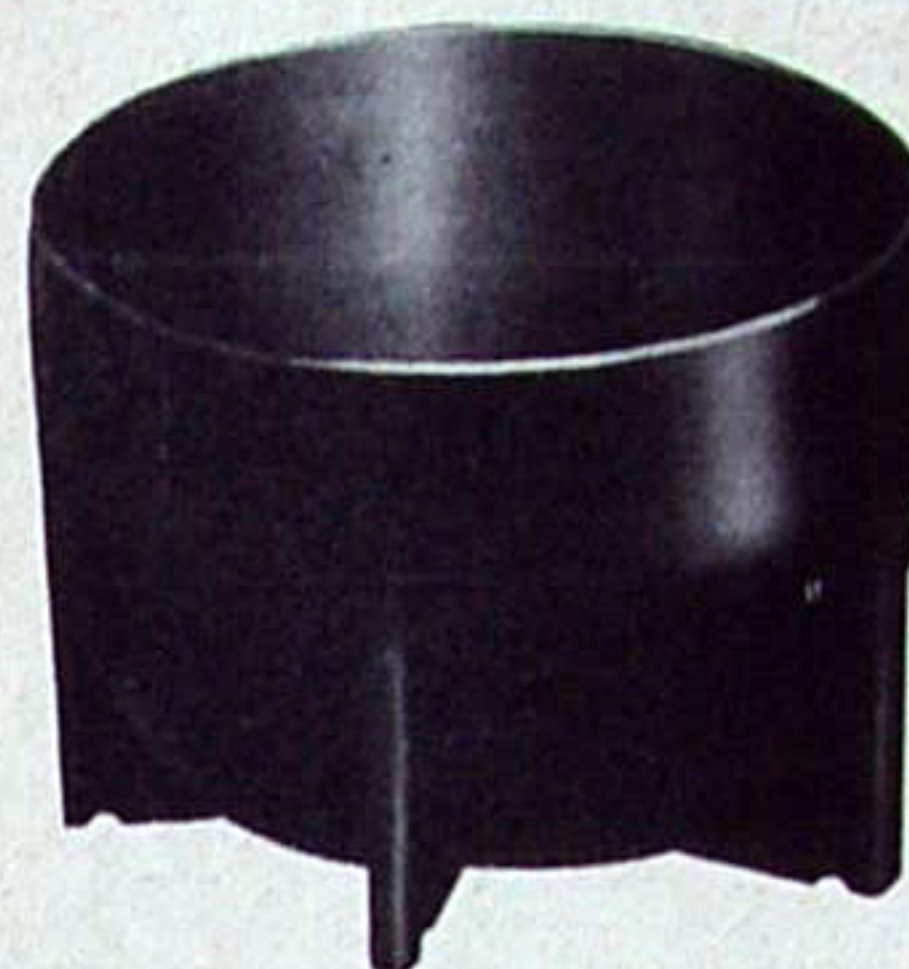

**WATERLUNG TANK BOOT**

Protective boot slips snugly over the bottom of any standard diameter cylinder. Made of black synthetic material which will not mark or mar surfaces. Flat bottom allows the cylinder to remain in vertical position.

1050 Waterlung Tank Boot (black) .....\$3.95

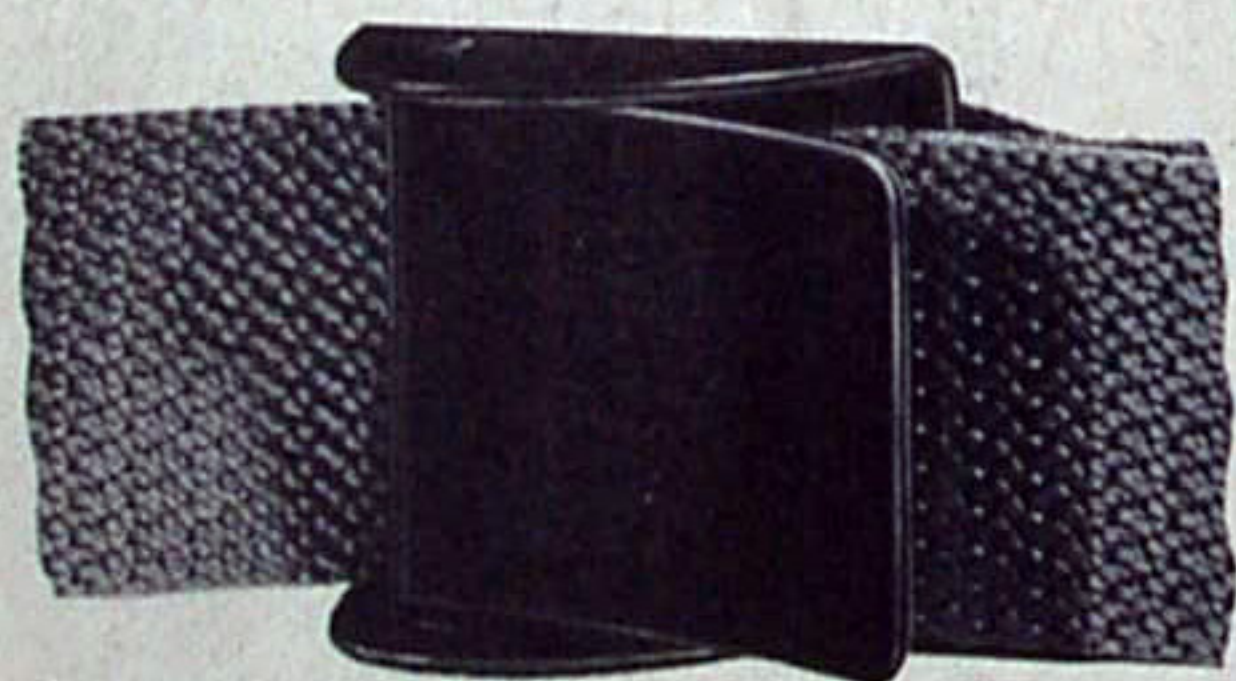

**"HYDRO-BELT"**

- Airplane type quick-release, all metal buckle. Black anodized finish.
- 2" orange or gray nylon belt.
- Stainless steel spring and pivot pin.
- Easy to slip lead weights on and off.

1291 Hydro-Belt, orange .....\$ 5.50

1293 Hydro-Belt, gray .....\$ 5.50

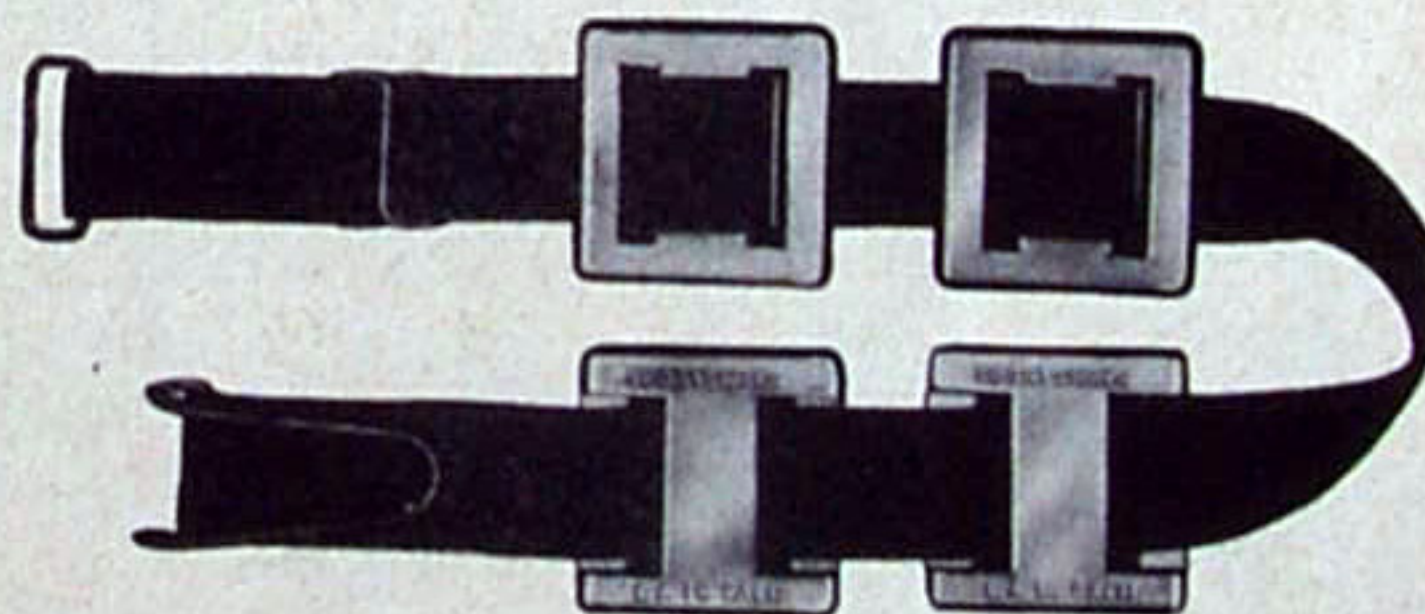

**WEIGHT BELTS & ACCESSORIES**

Cat. No. 1287 2" Pro Weight Belt with Four 3-lb. "Snug-Fit" Weights ..... 16.00

Cat. No. 1289 2" Pro Weight Belt without weights ..... 4.00

Cat. No. 1287-01 "Snug-Fit" 3-lb. Lead Weight (for 2" Belt) 2.95

Cat. No. 1286-02 2" Quick-Release Safety Buckle Assembly ..... 1.75



**PHOTO MURALS FOR THE CLUB ROOM — OFFICE  
— or DEN — UNDERWATER PHOTO MURALS**

Giant size 22" x 26" underwater photographs taken by Ron Church depicting diving activity in HAWAII, MEXICO, and CALIFORNIA. TWO COLORS, showing rare black coral, turtle diving, shell diving and underwater photography.

2507 Complete set of 4 prints .....\$1.50

**MOVIES — UNDERWATER MOVIES** — Clubs, Conventions, Fund raising organizations, meetings, diving promotion or home enjoyment. Here is a chance to purchase an exciting underwater movie to thrill your friends and acquaintances. Two exciting new films photographed and edited by Ron Church 1962 Underwater Photographer of the year. Sound, color, personally narrated.

**"MYSTERIES OF THE GULF" — Gold Medal Winner**

A fantastic color film depicting the mysterious underwater creatures of the Gulf of California. 15,000 Barracuda in one school, cleaning stations, garden eels and powerful game fish in feeding behaviors. "A short course in marine biology," 12 min. Sound, color.

2541 .....\$75.00

**"ADVENTURE UNDERWATER"**

Filmed at fabulous CAPE SAN LUCAS, home of the "Rivers of Sand." Exciting scenes catching turtles, spearing powerful game fish and defying a giant barracuda school. Feeding behaviors of predatory fish, a wall of fish. Taken from 35mm Eastman color, photographed and edited by Ron Church. 20 min. Sound, color.

2543 .....\$100.00

**"ANYONE FOR DIVING"**

A thirty-five minute film of general interest and the fun of diving . . . plus an up-to-date instructional aid with 7 min. of Walt Disney animation prologue. 16mm sound — Color . . . 35 min.

2545 .....\$140.00

**DIVING HANDBOOKS**

**DIVING MANUAL — "UNDERWATER RECREATION"**

A 72 page technical diving manual, illustrating the proper use of the underwater breathing equipment and skin diving techniques. Charts, photographs and illustrations for thorough readability.

2550 DIVING MANUAL .....\$2.50



# SPORTSWAYS, INC.

7701 E. COMPTON BLVD. • PARAMOUNT, CALIF.

# New Products for 1966

## NEW ITEMS



### TANKS WITH VALVES

- 702-1 Single Galv. 71.2 cu. ft. tank with SK Valve. Retail: **\$60.00**
- 702-2 Single Yellow 71.2 cu. ft. tank with SK Valve. Retail: **\$65.00**
- 702-3 Single Orange 71.2 cu. ft. tank with SK Valve. Retail: **\$65.00**
- 702-4 Single Galv. 71.2 cu. ft. tank with SJ Valve. Retail: **\$80.00**
- 702-5 Single Yellow 71.2 cu. ft. tank with SJ Valve. Retail: **\$85.00**
- 702-6 Single Orange 71.2 cu. ft. tank with SJ Valve. Retail: **\$85.00**

### THE "BIG INCH"—"O" RING SEALED 15/16" Opening

All SPORTSWAYS Tanks are Galvanized prior to applying the Exterior Paint to Prevent Rusting.

- 701-1 Bare Tank, 71.2 cu. ft. Galvanized ..... Retail: **\$50.00**
- 701-2 Bare Tank, 71.2 cu. ft. Yellow ..... Retail: **\$55.00**
- 701-3 Bare Tank, 71.2 cu. ft. Orange ..... Retail: **\$55.00**

### TANKS WITH VALVES & PACS

- 708-1 Double Galv. Tanks with SK2 Valve, with Contour Pac  
Retail: **\$156.00**
- 708-2 Double Yellow Tanks with SK2 Valve, with Contour Pac  
Retail: **\$166.00**
- 708-3 Double Orange Tanks with SK2 Valve, with Contour Pac  
Retail: **\$166.00**
- 708-7 Double Galv. Tanks with SJ2 Valve with Contour Pac  
Retail: **\$175.00**
- 708-8 Double Yellow Tanks with SJ2 Valve with Contour Pac  
Retail: **\$185.00**
- 708-9 Double Orange Tank with SJ2 Valve with Contour Pac  
Retail: **\$185.00**

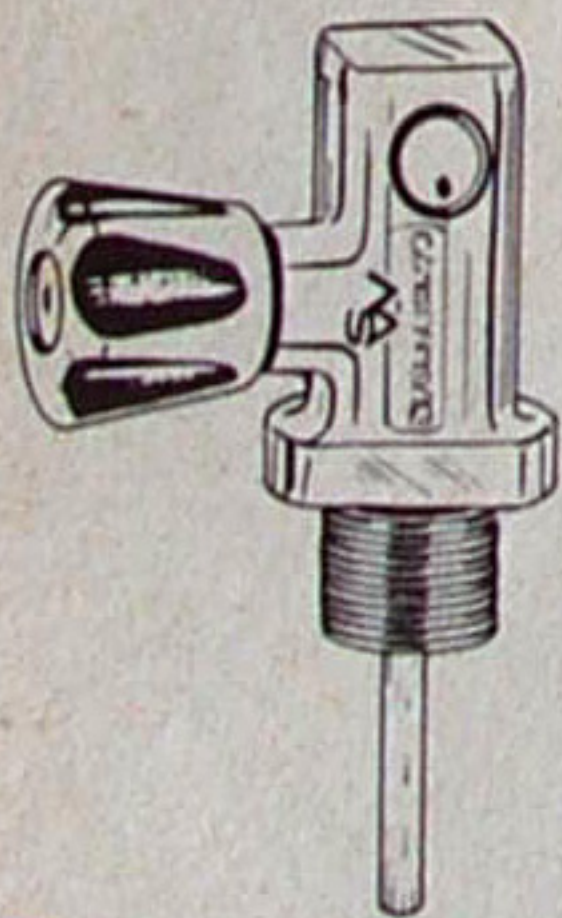

#### "SK" SHUT-OFF VALVE

SK Tank Valve 3/4" Straight Pipe Thread for 15/16" Tank Opening.

704 ..... Retail **\$12.00**

SK2 Double Tank Manifold 3/4" Straight Pipe Thread for 15/16" Opening.

704B ..... Retail **\$39.00**

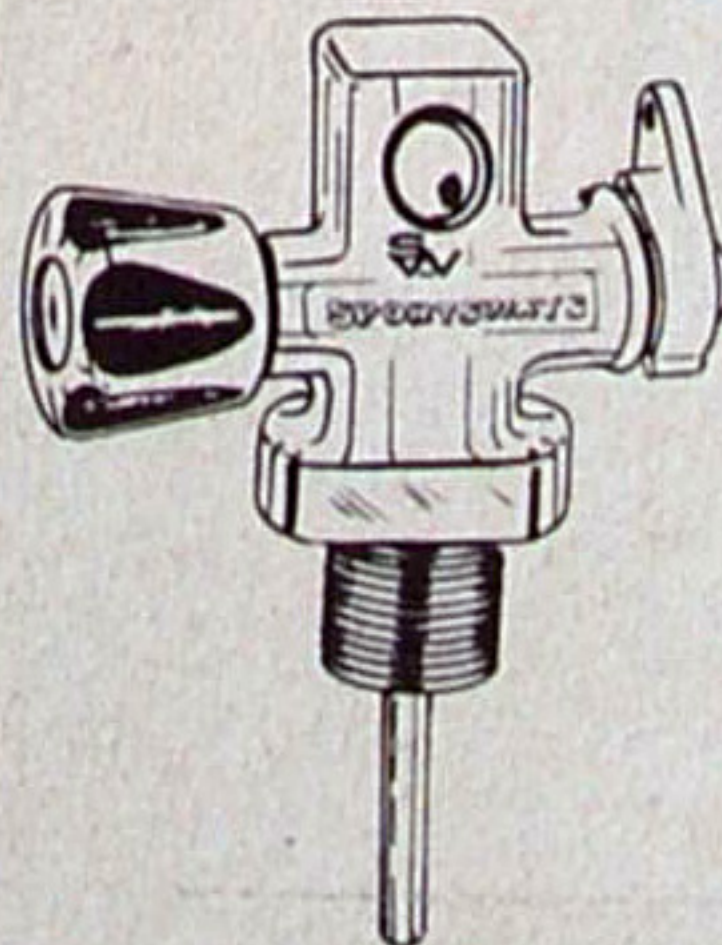

#### "SJ" CONSTANT RESERVE VALVE

SJ Tank Valve 3/4" Straight Pipe Thread for 15/16" Tank Opening.

704A ..... Retail **\$32.00**

SJ2 Double Tank Manifold 3/4" Straight Pipe Thread for 15/16" Tank Opening.

704C ..... Retail **\$55.00**



## FROGMAN SEA SPEAR

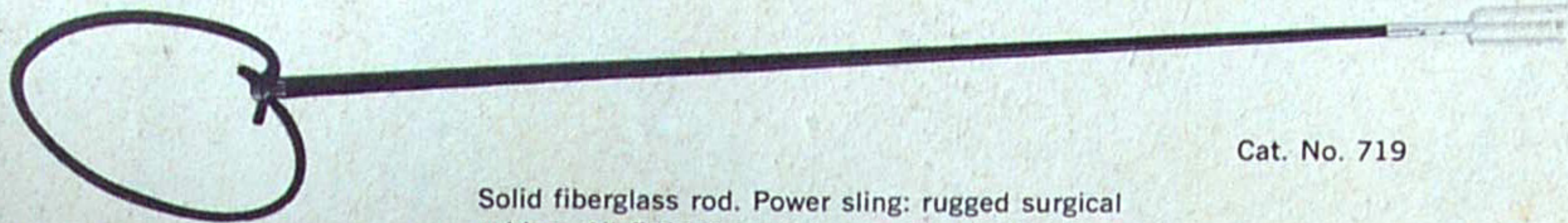

Cat. No. 719

Solid fiberglass rod. Power sling: rugged surgical rubber. All fittings corrosion resistant. American thread. Three-prong spear head. Length - 4'.

Retail ..... 8.95

## SPORTSMAN SEA SPEAR

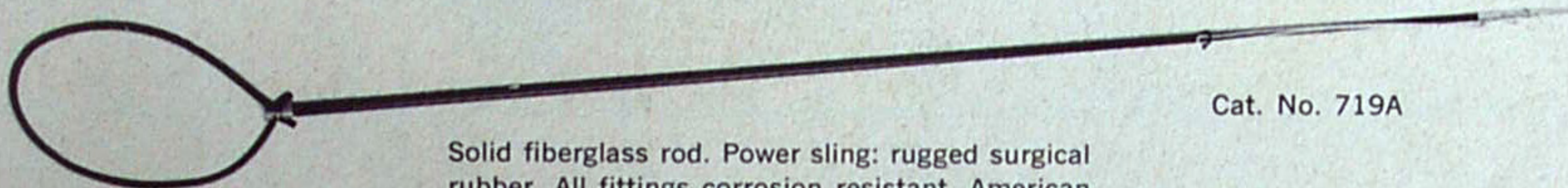

Cat. No. 719A

Solid fiberglass rod. Power sling: rugged surgical rubber. All fittings corrosion resistant. American thread. 3" slip tip detachable tri-cut spearhead. Length - 5'6".

Retail ..... 11.50

## COMPETITOR SEA SPEAR

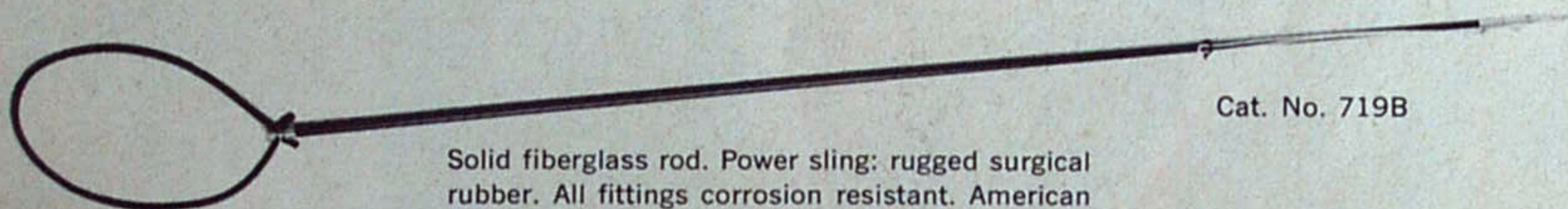

Cat. No. 719B

Solid fiberglass rod. Power sling: rugged surgical rubber. All fittings corrosion resistant. American thread. 3" slip tip detachable tri-cut spearhead. Length - 7'6".

Retail ..... 18.95

## FROGMAN GUN

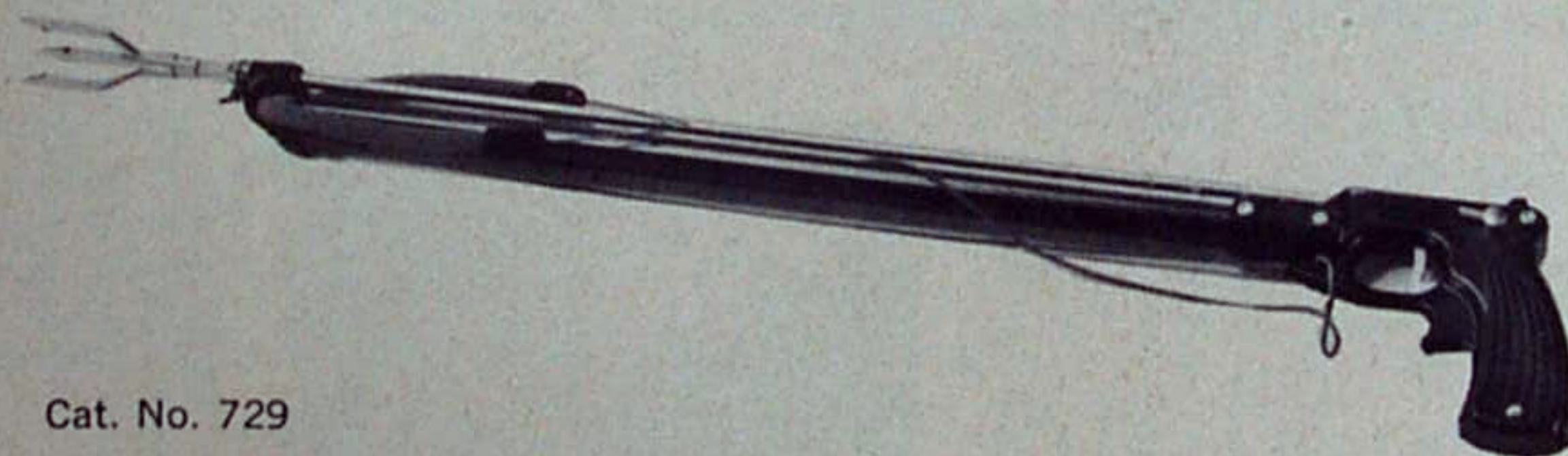

Cat. No. 729

Retail ..... 12.00

## ZUKA-SLURP GUN

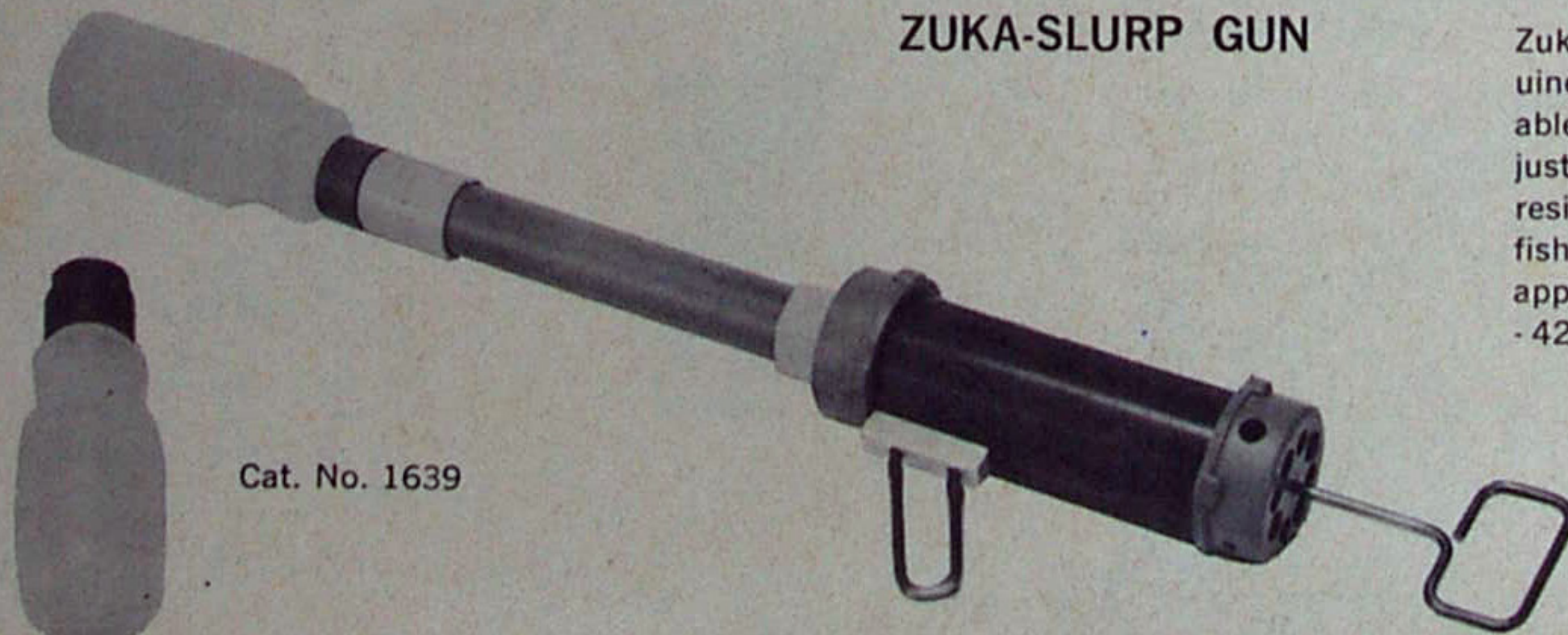

Cat. No. 1639

Retail ..... 28.95

Zuka-Slurp Gun manufactured of genuine P.V.C. Pump type action. Detachable fish traps, linear polyethylene. Adjustable length. Metal parts corrosion resistant. Free of maintenance. Extra fish traps available. This is a realistic approach to "slurping". Overall length - 42".



## DIVERS KNIFE—STEELHEAD

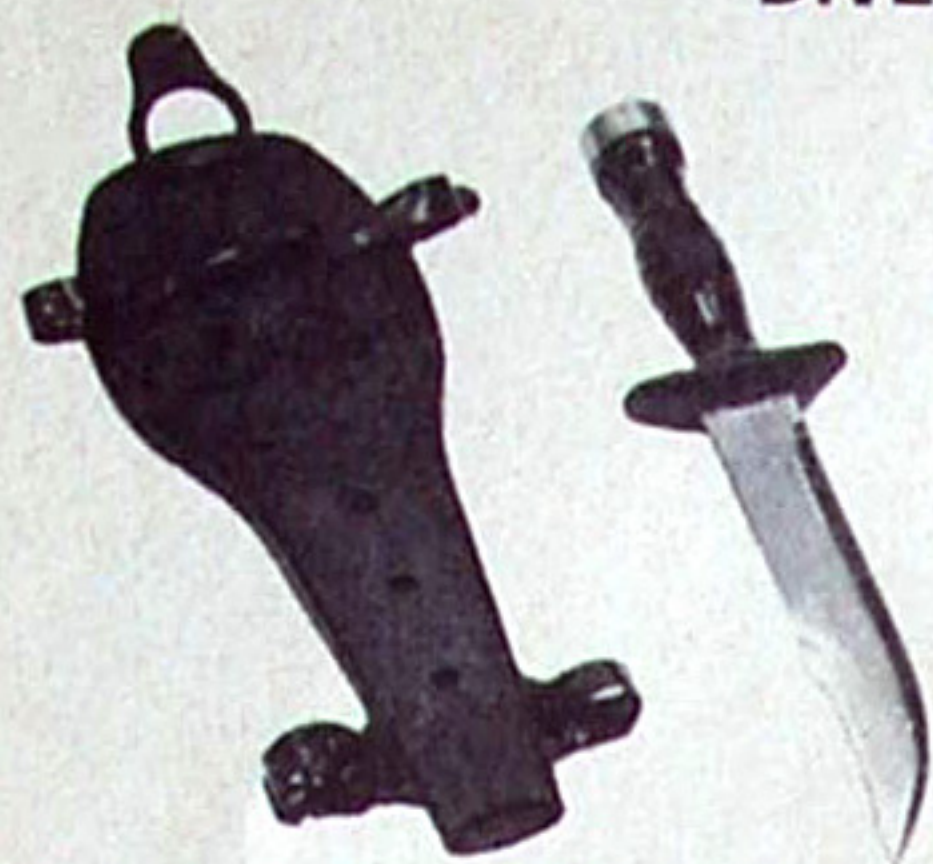

Stainless steel head. Versatile heavy-duty diver's knife.  
Cat. No. 713-3

Retail ..... 11.95

## NAVY PRESSURE VEST



Built to the specifications of the Sportsways ever-popular Navy Safety Vest with added 16 gram cartridges and an over inflation purge valve. International Orange.

Cat. No. 1830

Retail ..... 31.95

## SHARK MASK



Anodized band. Protective band screw covering. Interlocking head strap. Tempered lens. Beautifully contoured.

Cat. No. 706

Retail ..... 6.95

## REPAIR MANUAL



Cat. No. 728

Retail ..... \$ 5.00

## "WATERLUNG" REGULATOR CARRY BAG



Gold expandable vinyl trimmed with black vinyl nylon zipper.

Cat. No. 721-3

Retail ..... 3.25

## CARRY-ALL BAG



All heavy-duty canvas material with water-proof backing. Double brass zipper. Double handles. Reinforced bottom. Ideal for carrying masks, fins, snorkels, gauges, suits, regulators, etc.

Cat. No. 721-2

Retail ..... 8.95

## PORT-A-LIFT



A submersible lifting device. Lift anchors, motors, wreckage, moorings, small boats, cannons, timbers, salvage of all kinds.

Any depth, any weight — up to rated capacity. The 100-pounder uses only 3½ cubic feet at a depth of 33 feet (about 2 minutes of your air supply). The 200-pounder uses 7. Larger Port-A-Lifts call for the use of a spare tank: 17 cubic feet of air for the 500-pounder, or 33 for the 1000 pounder (at a depth of 33 feet).

Made of rugged vinyl, fully vented to prevent over-expansion during ascent.

Cat. No. 721-5 200 lbs.

Cat. No. 721-6 500 lbs.

## LOBSTER BAG



World's newest amphibian. On land a catchall for lugging flippers, mask, hood, and other gear. Under water it hangs out of the way on wrist, float, or float-line. Snaps open at a touch to swallow up fish, lobster, abalone, scallops, marine or mineral specimens.

The Lobster Bag won't rip, rot, rust, or bust. Its light, strong nylon mesh that can't cause excessive drag in water.

Cat. No. 721-4





## DOLPHIN JUNIOR SWIM SET

The Dolphin Junior Swim Set incorporates the Dolphin Junior Flipper, Dolphin Junior Mask, and Dolphin Junior Snorkel available in three different fin sizes.

1930	Sizes 2 - 3
1931	Sizes 3 - 4
1932	Sizes 4 - 5

Retail ..... 10.95

## DOLPHIN JR. FLIPPERS

The fin that was designed for the ever-growing flipper fan. Designed to the exact demands found incorporated in our ever-popular "Waterlung Fins". Comfortable foot pocket. Contoured ribs. Adjustable to the growing foot. Instructions included with each pair of fins for their adaptation to the growing foot.

1920	Sizes 2 - 3
1921	Sizes 3 - 4
1922	Sizes 4 - 5

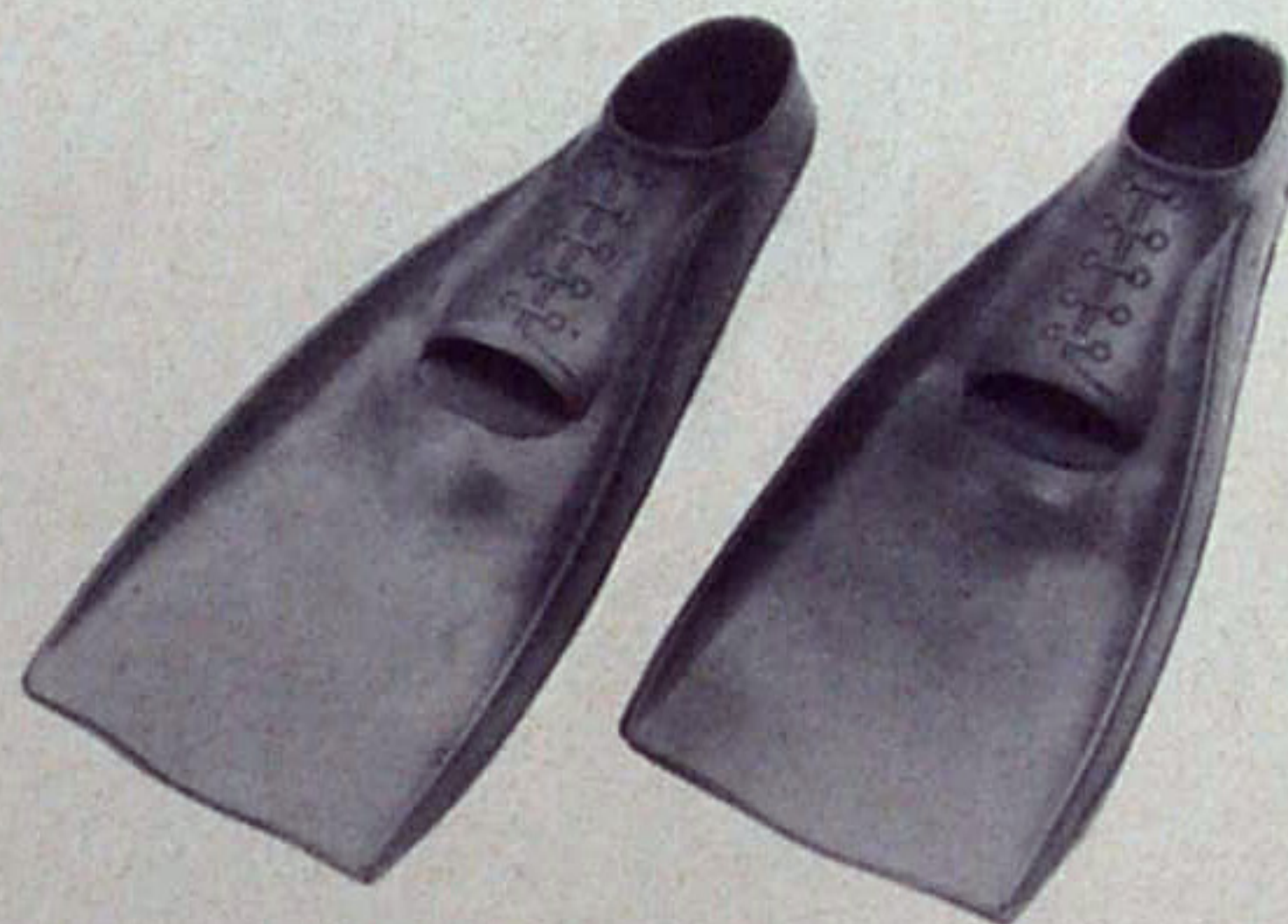

Retail ..... 5.95

## DOLPHIN JR. MASK

Designed especially for the junior flipper fan. Beautifully contoured to fit the most exacting demands of the smaller face. Feathered edging makes for perfect sealing. Snug tight fit headstrap, locking to assure direct pull, eliminating crinkling edges. Tempered lens. Stainless steel band. Brass nickel plated buckles. Beautiful Ocean Blue color. Professionally split comfortable head strap. Extremely slanted lens providing better viewing for the diver. Short top skirt aids sealing.

1910



Retail ..... 3.95

## DOLPHIN JR. SNORKEL

Designed especially for the junior flipper fan. Soft contoured mouthpiece. All rubber one-piece tube. The professional look.

1900



Retail ..... 1.00





## SURF AND SKI VEST — NO SLEEVES

1/8" skin one side. Stretch quality nylon. Nickel plated brass zipper. Double stitched dacron thread. Seams taped with rubber to prevent chaffing. Rubatex material. Fully guaranteed against defects in material and workmanship.

- 5810
- 5811
- 5812
- 5813
- 5814

- Extra Small
- Small
- Medium
- Large
- Extra Large

## SURFER'S SUIT — WITHOUT SLEEVES

1/8" nylon lined — skin outside. Stretch quality nylon. Nickel plated brass zipper. Double stitched dacron thread. Seams taped with rubber to prevent chaffing. Rubatex material. Fully guaranteed against defects in material and workmanship.

- 5610
- 5611
- 5612
- 5613
- 5614

- Extra Small
- Small
- Medium
- Large
- Extra Large



## SURF & SKI JACKET WITH BEAVER TAIL — SHORT SLEEVES

3/16" skin two sides. Stretch quality nylon. Nickel plated brass zipper. Double stitched dacron thread. Seams taped with rubber to prevent chaffing. Rubatex material. Fully guaranteed against defects in material and workmanship.



- 5560
- 5561
- 5562
- 5563
- 5564

- Extra Small
- Small
- Medium
- Large
- Extra Large



A HOOKAH UNIT SIMPLY COMBINES THE WATERLUNG REGULATOR AND A SURFACE AIR SUPPLY. THE UNIT IS CONNECTED TO A SURFACE AIR SOURCE BY A MEDIUM PRESSURE HOSE. IDEAL FOR DIVING IN A LIMITED AREA FOR EXTENDED PERIODS OF TIME, SUCH AS FOR GOLD DIVING OR MANY TYPES OF UNDERWATER REPAIR AND SALVAGE.

## COMPRESSORS

### BARE HOOKAH COMPRESSOR

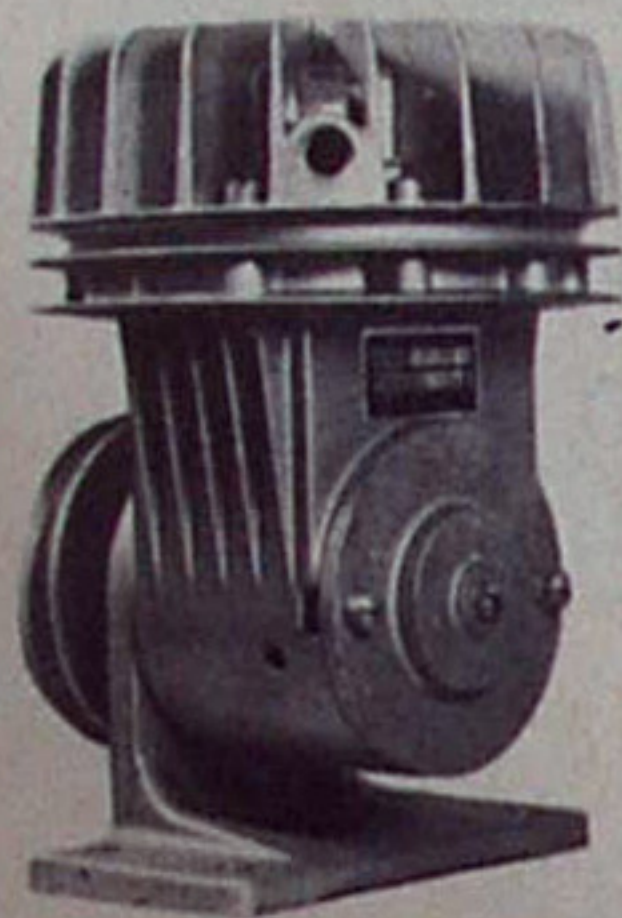

1. Capacity 3.5 C.F.M.
2. Pressure 100 P.S.I.
3. Weight 7 lbs. (All Aluminum)
4. R.P.M. 1200
5. Pre-lubricated, sealed bearings, no lubrication or filtering required.

744-1

Retail: \$75.00

### ELECTRIC COMPRESSOR

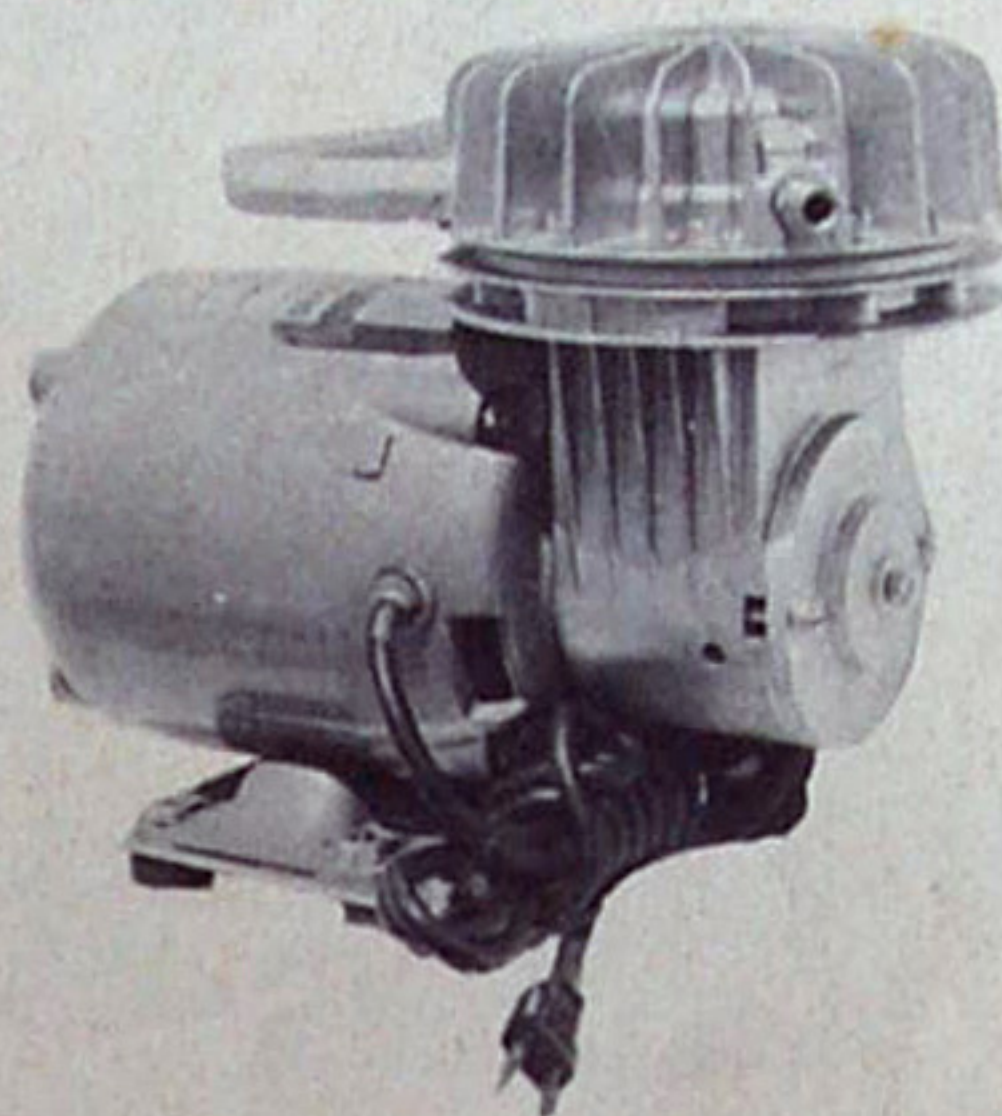

1. This model is powered by a 1/3 H.P. Electric motor coupled directly to Sportsways compressor for minimum weight, size, and maintenance.
2. Capacity 3.5 C.F.M.
3. Weight 37 lbs.

744-2

Retail: \$100.00

### UTILITY ELECTRIC COMPRESSOR

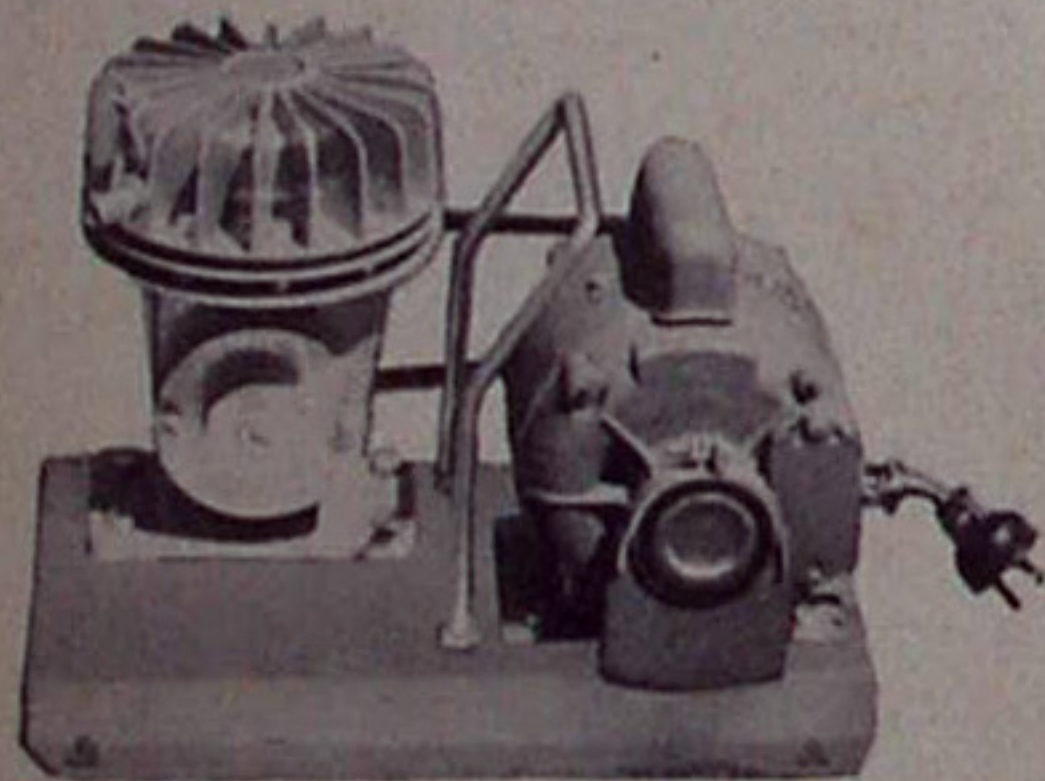

This model is belt driven and has a pressure relief valve adjustable to 100 P.S.I., pre set to 55 P.S.I. for continuous operation, and prolonged life. The 1/3 H.P. electric motor and 3.5 C.F.M. compressor is shock mounted.

744-3

Retail: \$140.00

### SINGLE GASOLINE DRIVEN COMPRESSOR

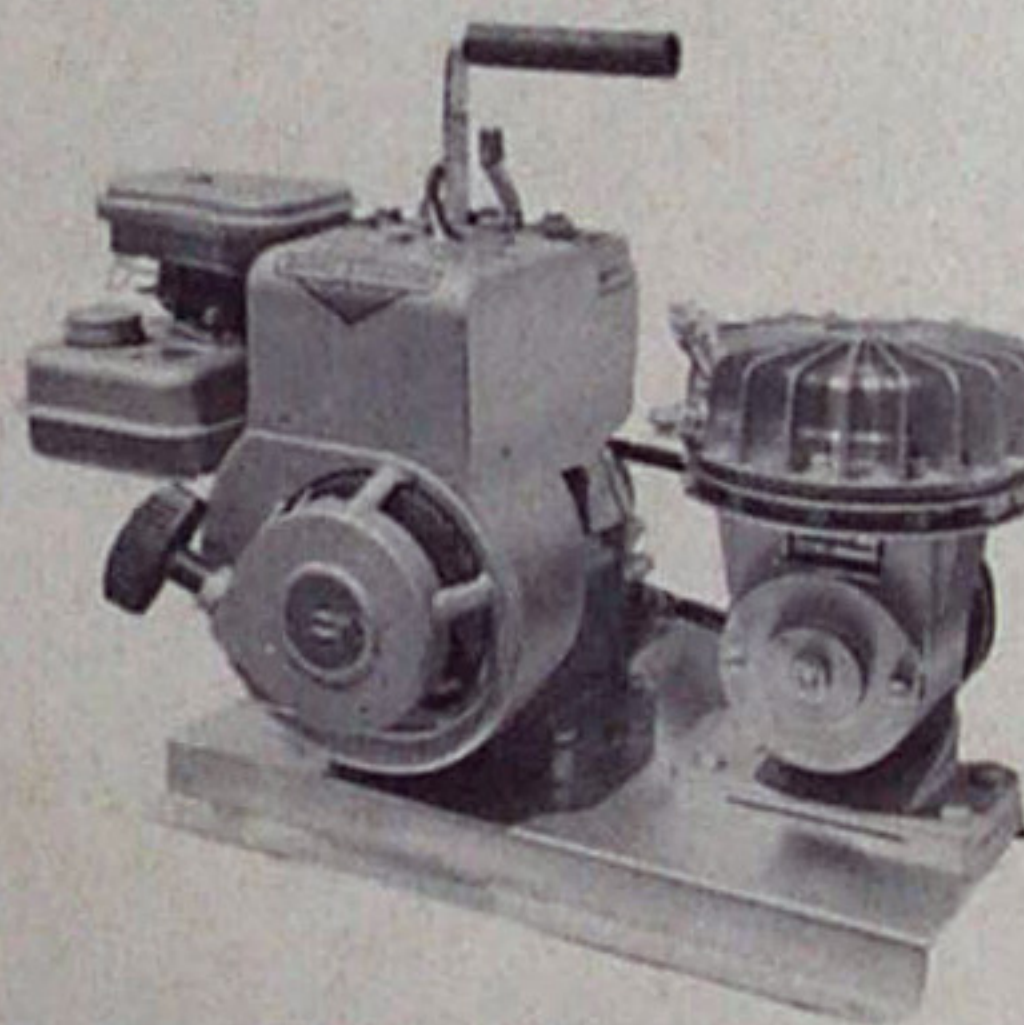

2 H.P. lightweight aluminum, air cooled Briggs & Stratton motors, completely portable weighing only 37 lbs. This model has a recoil starter and is shock mounted. Capacity 3.5 C.F.M.

744-4

Retail: \$185.00

### DOUBLE GASOLINE DRIVEN COMPRESSOR

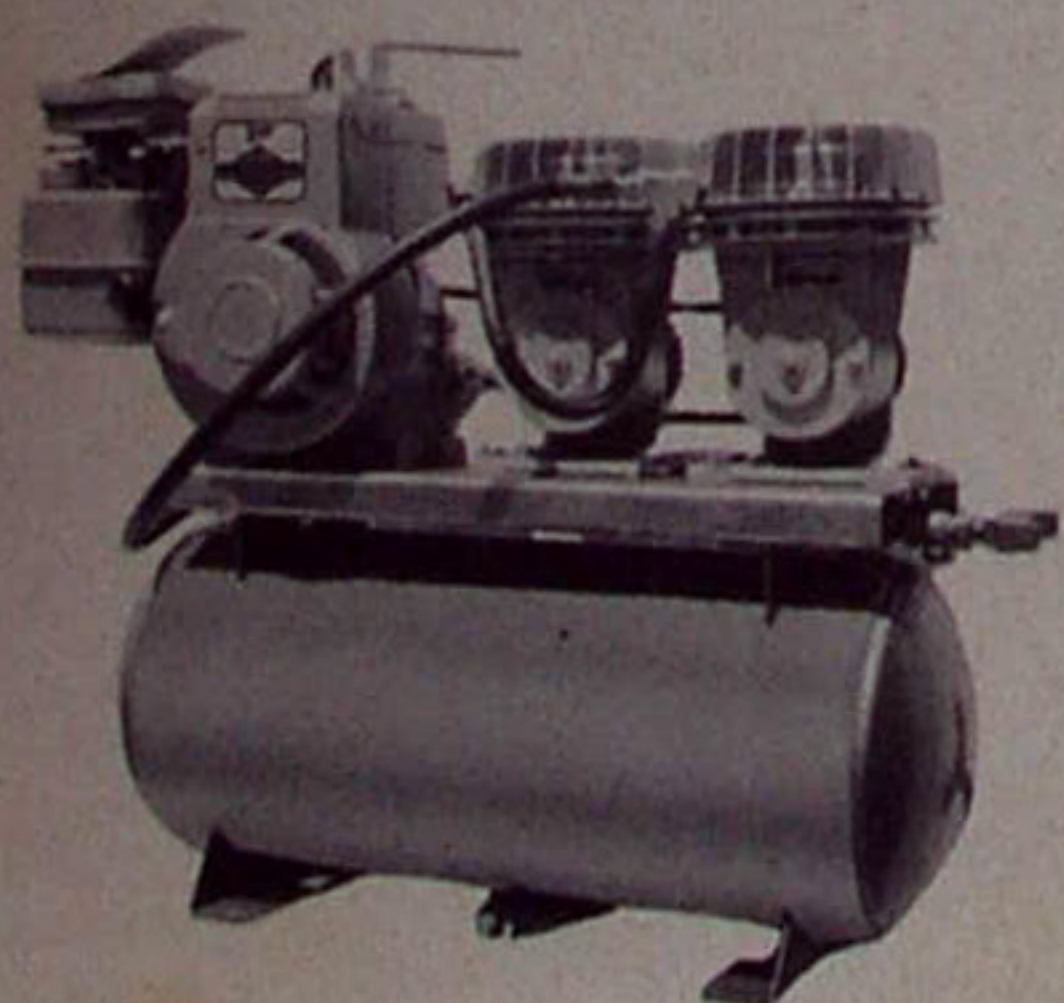

3 H.P. lightweight aluminum, air cooled Briggs and Stratton motors with recoil starter and adaptable to mount on storage tank. This model has 2 Sportsways compressors mounted in line providing 7 C.F.M. at pressures up to 100 P.S.I. Commonly used in depths of 100 ft. or more.

744-5

Retail \$300.00

### AIR RESERVE VOLUME TANK

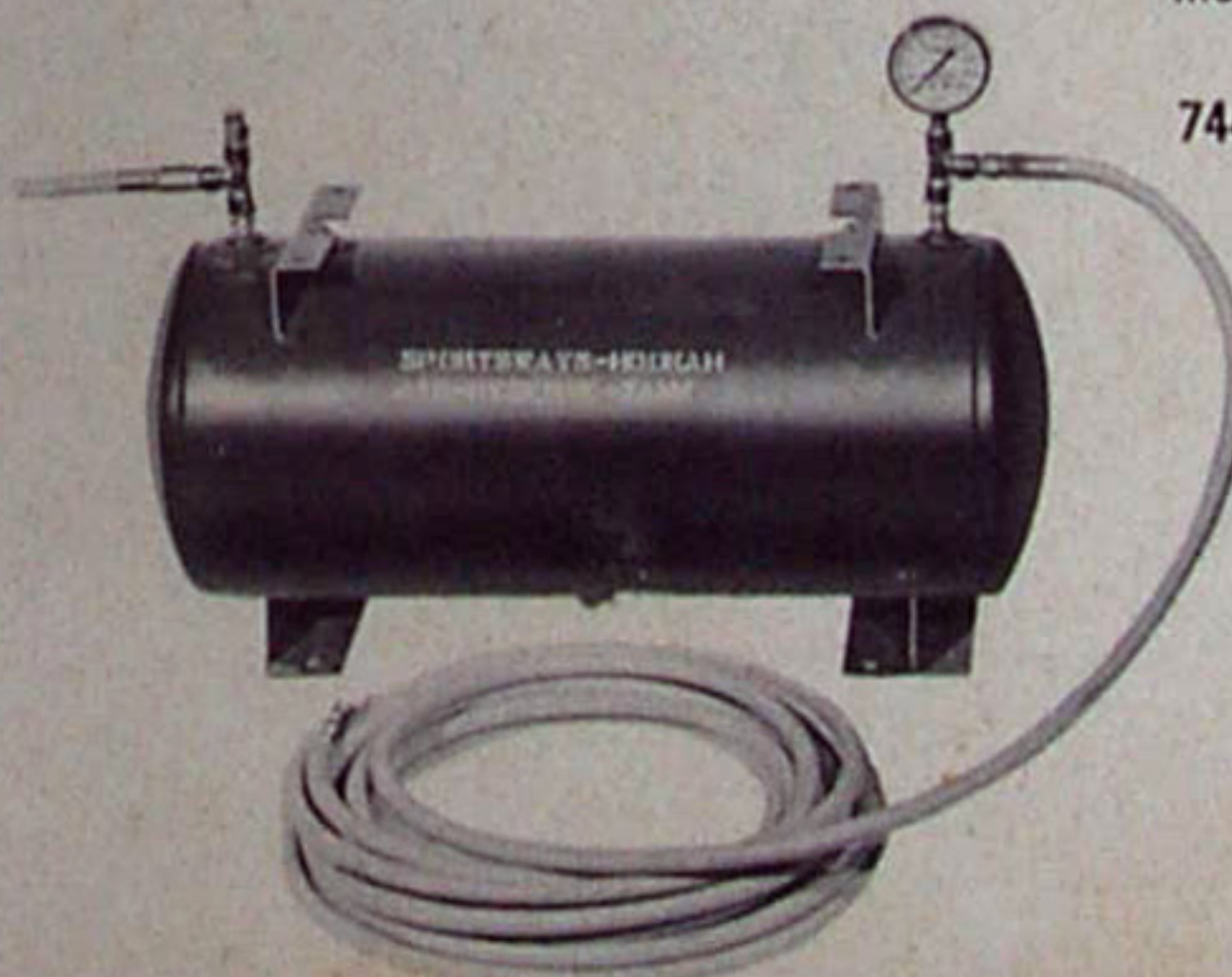

Size 12 x 24 — 100 P.S.I. working pressure. Outlet for drain plug for discharging moisture condensation.

744-6

Retail: \$55.00



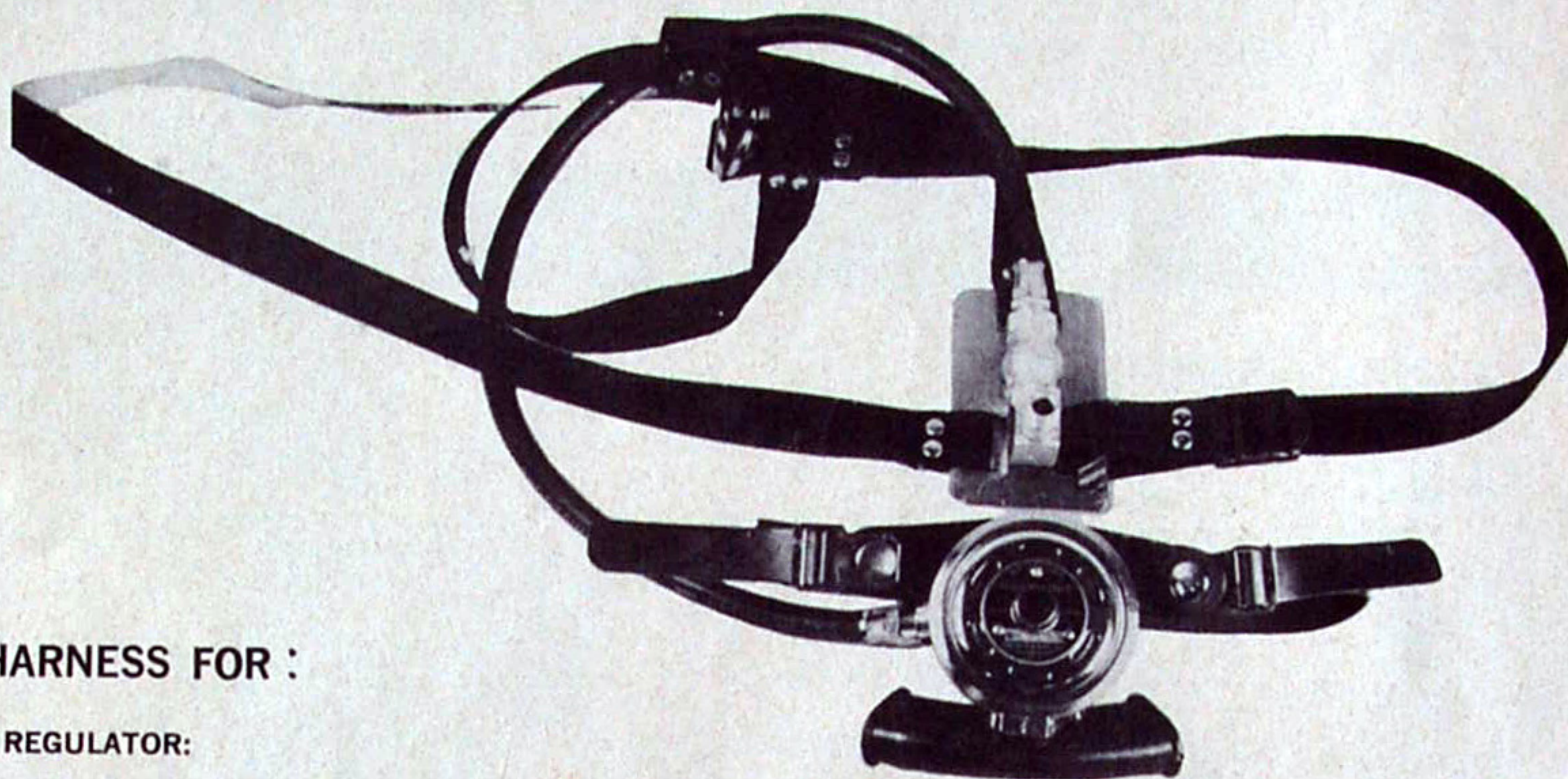

## HOOKAH HARNESS FOR :

### SINGLE HOSE REGULATOR:

Designed to fit all Sportways Single Hose regulators, with easily adjustable nylon straps. Harness comes complete with check valve and adaptable fittings.

### DOUBLE HOSE REGULATOR:

Designed to fit all Sportways Double Hose regulators with adjustable nylon straps, check valve and adaptable fittings.

Cat. No. 744-9  
Retail: Single - \$40.00

Cat. No. 744-10  
Double - \$45.00

## RESERVE TANK FLEXIBLE HOSE CONNECTOR

26" section of diving 5/16 Hookah hose coupled for connecting compressor to reserve tank.

744-8

Retail: \$5.00

## HOOKAH COMPRESSOR HOSE AND HARDWARE KIT

This kit contains the necessary valves, connectors and hoses to utilize the reserve tank. It contains the following: Flexible hose connector, inlet check valve, adjustable pressure relief valve, drain plug, and all connectors to adapt same.

744-7

Retail: \$47.00



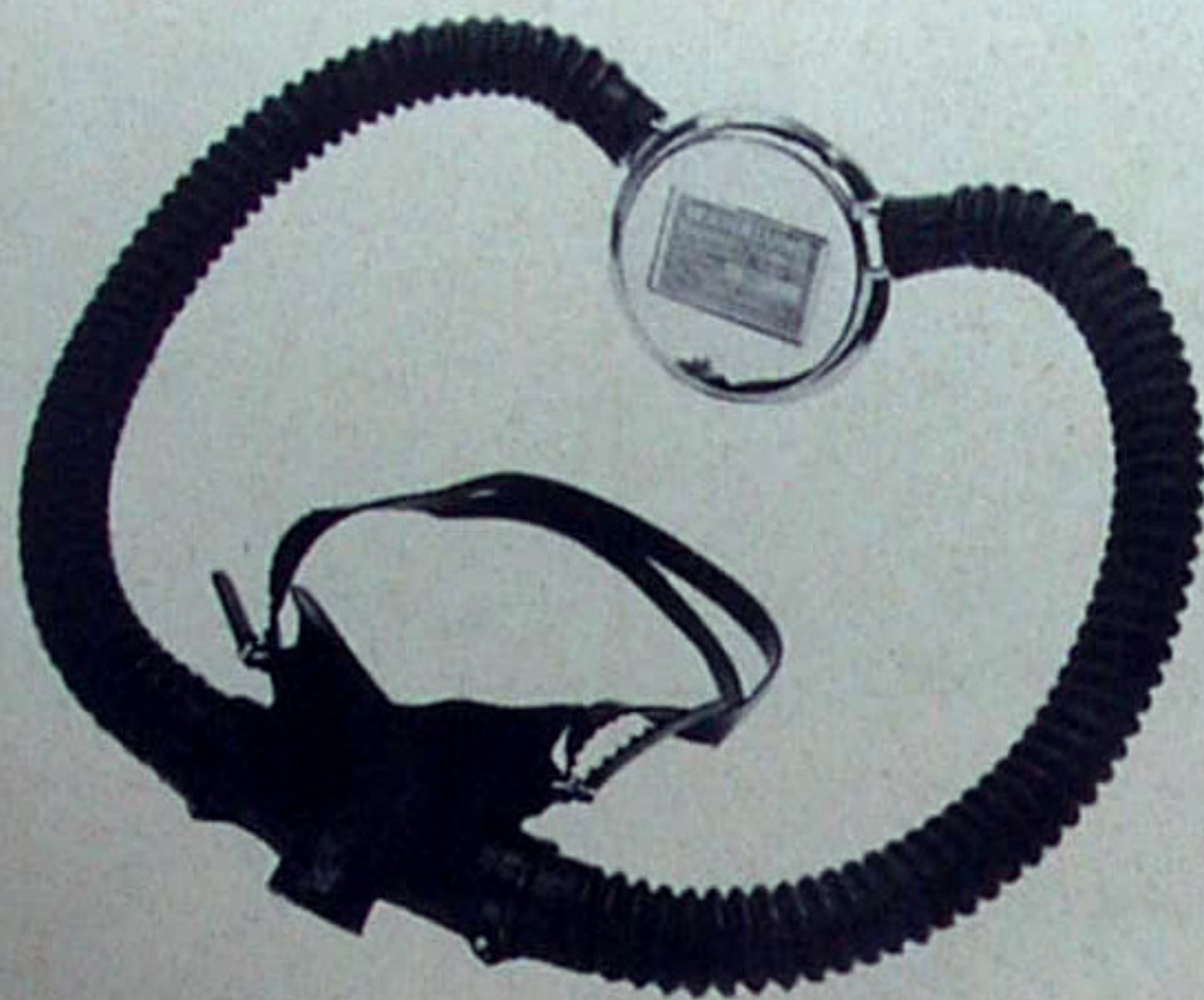

**HYDRO TWIN NAUTILUS**

The only two-hose regulator made with these unique features:

- First Stage "balanced valve".
- Large demand diaphragm provides super-sensitive response.
- Sea-View Gauge port. Solid one piece forging.
- All vital metal parts made of stainless steel.
- Equipped with Nautilus Mouthpiece.
- Talking Regulator — Permits clear and normal speech underwater.
- Mouthpiece accepted by Professional and Navy divers.
- Mouthpiece now being used by U.S. Navy with underwater communication equipment.
- Eliminates jaw cramps and sore gums (no hard rubber mouthbit to bite on).
- Contains an exclusive speech chamber. Nautilus Mouthpiece has been recognized as the best for use with underwater communications equipment.
- Easy equalizing (with no mouthbit to interfere with swallowing).

Cat. No.	Retail
732-A-1 .....	<b>\$105.00</b>
With Sea-View Gauge 732A-2 .....	<b>125.00</b>



**ORCA NAUTILUS**

SPORTSWAYS ORCA . . . Designed to meet our highest quality standards.

- Pre-set "piston type" first stage, reliable and simple.
- SPORTSWAYS "downstream valve" made of stainless steel in second stage.
- Light weight, two-stage, single hose regulator.
- Talking Regulator — Permits clear and normal speech underwater at close range.
- Mouthpiece accepted by Professional and Navy divers.
- Mouthpiece now being utilized by many research and development teams with underwater communication equipment.
- The only regulator with built-in snorkel, with easy to operate Off-On valve.
- Eliminates jaw cramps and sore gums (no hard rubber mouthbit to bite on).
- Contains an exclusive speech chamber. Nautilus Mouthpiece has been recognized as the best for use with underwater communications equipment.
- Easy equalizing, (with no mouthbit to interfere with swallowing).
- Comfortable, dry-breathing mouthpiece keeps lips and face warm.
- Orca Nautilus has built-in snorkel for direct buddy breathing. No need to switch regulator back and forth.

Cat. No.	Retail
732-1 .....	<b>\$ 95.00</b>
With Sea-View Gauge 732-2 .....	<b>115.00</b>



## CONVERSION KIT — TWO HOSE REGULATOR

Parts required:

1. Mouthpiece — Nautilus I
2. Exhaust Valve
3. Purge Valve Clamp

736-A .....	Retail \$25.00
735 — Mouthpiece Only .....	Retail \$ 17.95

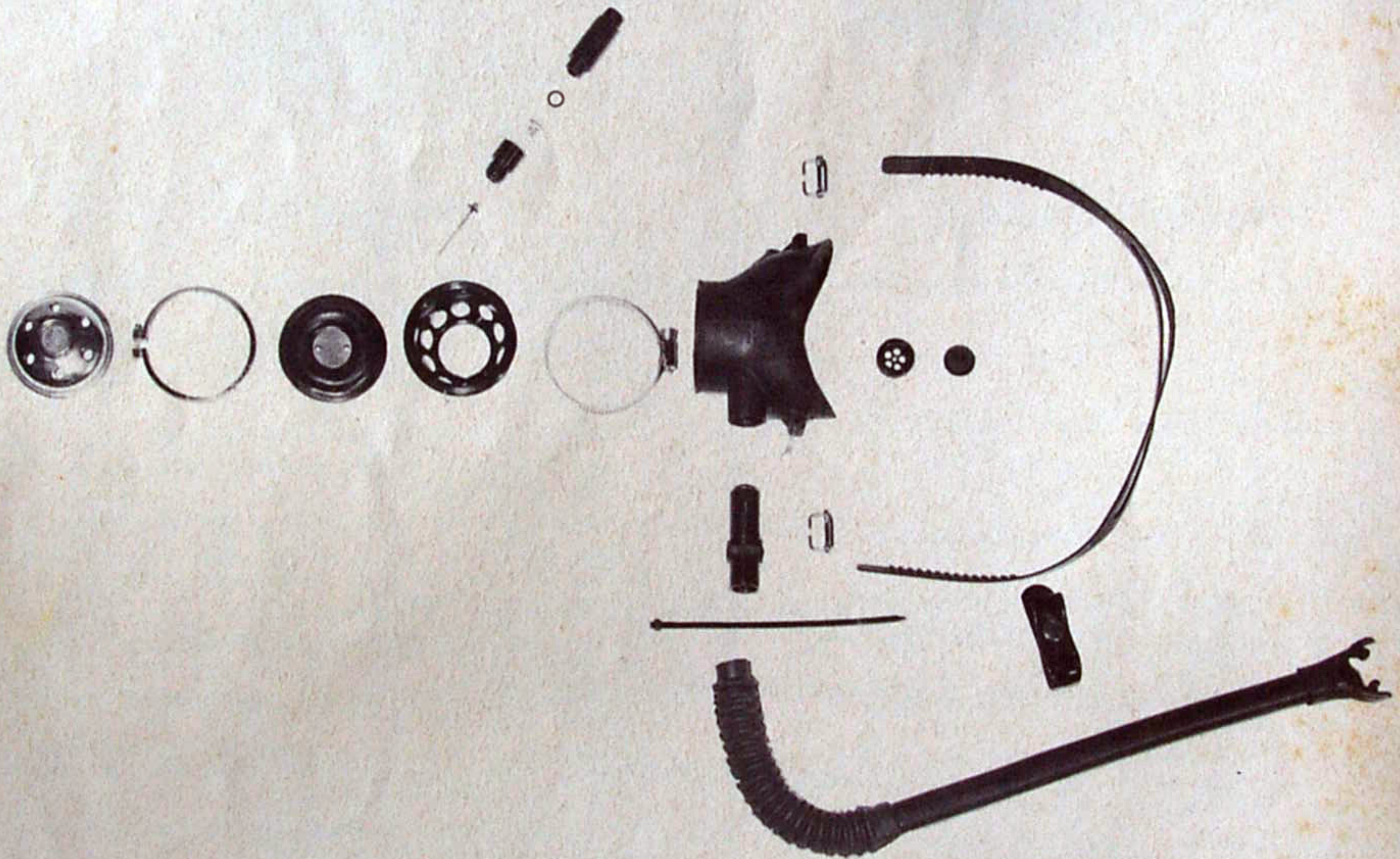

## CONVERSION KIT — SINGLE HOSE REGULATOR

Parts required:

1. Mouthpiece, Nautilus II
2. Regulator Housing
3. Valve Housing
4. Exhaust Valve
5. Snorkel Valve
6. One Mouthpiece Clamp
7. Snorkel Clamp
8. Air Intake Clamp
9. 45" Hose Available for Inversion of Tanks

736-1 .....	Retail \$60.00
With Tilt Valve	
736-2 .....	62.00
With Downstream Valve	





*America's Finest*

**BARBELLS  
DUMBELLS  
EXERCISING EQUIPMENT**

**HEALTH + VITALITY =**

**DEDICATED**

"We, at CHAMPION, are dedicated to America's physical fitness program for all age groups. Further, we champion the program of profit for retailers who provide the health-giving equipment to satisfy the nation's enthusiasm for fitness: CHAMPION proudly presents the 1966 line."

HARVEY MELVIN,  
*President*

**STRENGTH and BODY BUILDING**

7701 EAST COMPTON BLVD. PARAMOUNT, CALIF.

TEL. AREA CODE 213 NE 6-9771



# BARBELLS

Cat. No. 102 **CHAMPION 110 LB. DELUXE BARBELL COMBINATION**  
Retail \$28.95 ea.

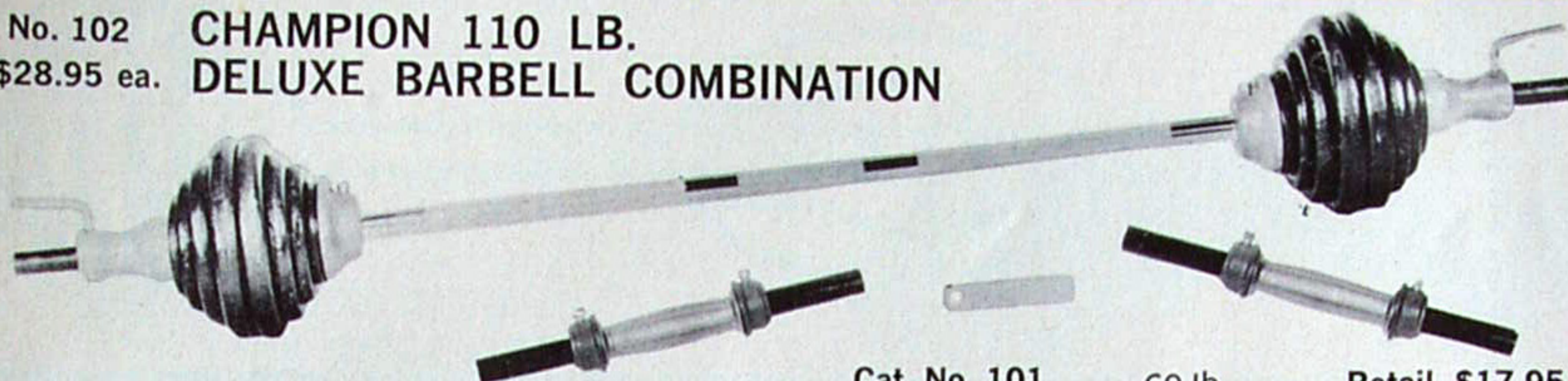

Cat. No. 101	60 lb.	Retail \$17.95 ea.
Cat. No. 103	160 lb.	Retail \$38.95 ea.
Cat. No. 104	210 lb.	Retail \$49.95 ea.
Cat. No. 105	215 lb.	Retail \$53.95 ea.

**CHAMPION CHROME PLATED, KNURLED "JUNIOR CHAMP" BARBELL SET**

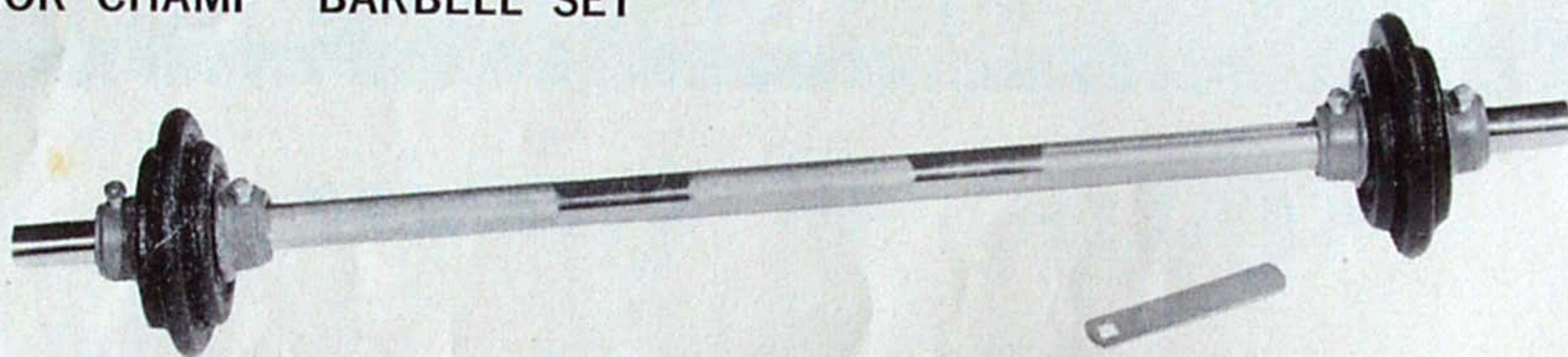

34" long... weight 15 lbs.

Retail \$7.95  
Cat. No. 107

**DELUXE SOLID STEEL REVOLVING DUMBBELL BARS**

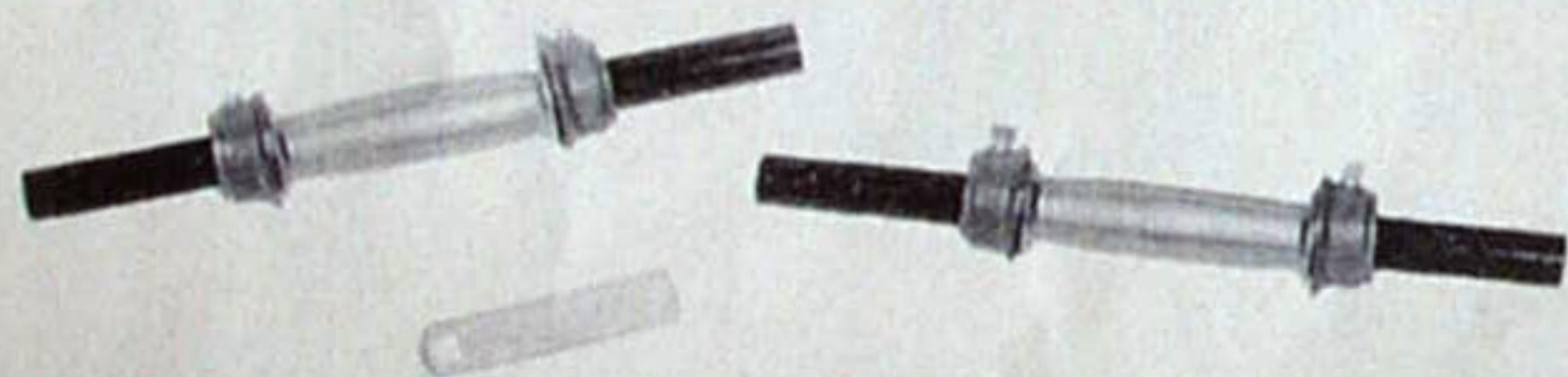

Cat. No. 142	—12"	Retail \$3.95 pr.
Cat. No. 143	—14"	Retail \$3.95 pr.



DELUXE SOLID STEEL REVOLVING BARS

Cat. No. 144	—4'	Retail \$10.95 ea.
Cat. No. 145	—5'	Retail \$11.95 ea.
Cat. No. 146	—6'	Retail \$13.95 ea.

## REVOLVING DUMBBELL

## BARBELL PLATES

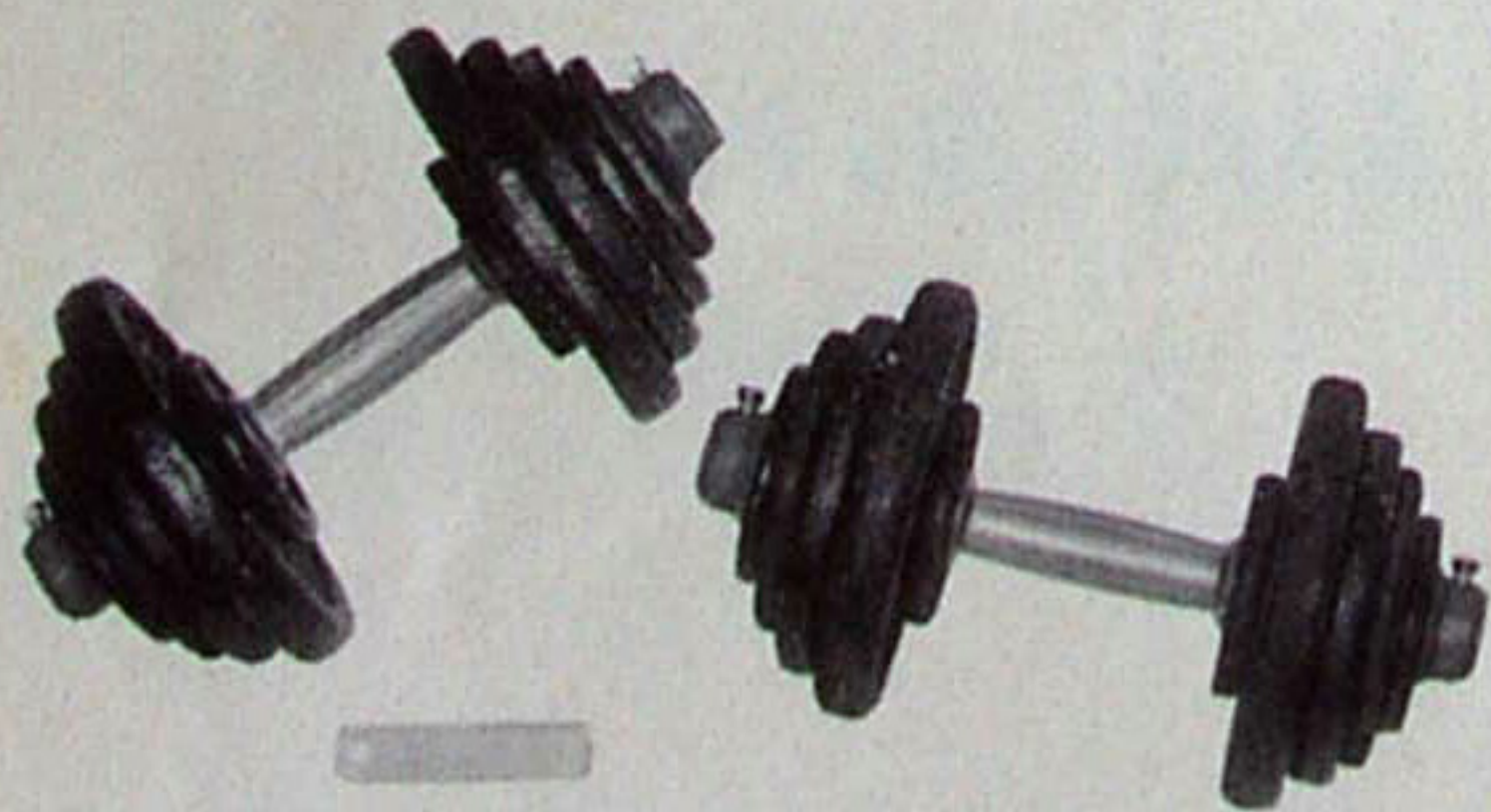

**CHAMPION DELUXE REVOLVING DUMBBELLS**

Cat. No. 120	30 lb.	Retail \$10.95 set
Cat. No. 121	50 lb.	Retail \$14.95 set
Cat. No. 122	70 lb.	Retail \$18.95 set
Cat. No. 123	90 lb.	Retail \$23.95 set

**CHAMPION DELUXE BARBELL PLATES**

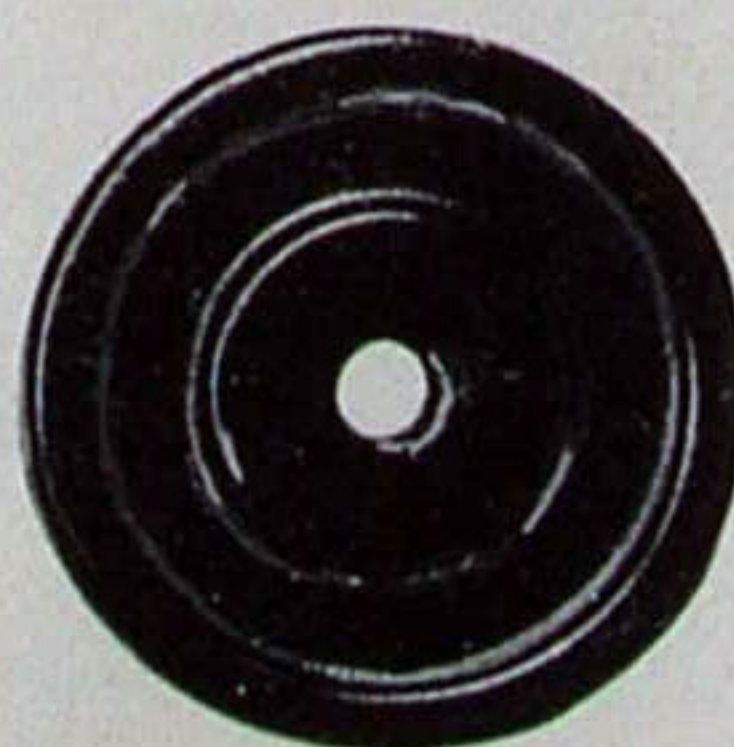

Cat. No.		Retail
147	1 1/4 lb.	\$ .32 ea.
148	2 1/2 lb.	.63 ea.
149	5 lb.	1.25 ea.
150	10 lb.	2.50 ea.
151	25 lb.	6.25 ea.
152	50 lb.	12.50 ea.





## CHAMPION SHOT

IRON		Retail
Cat. No.		
171	6 lb.	3.25 ea.
172	8 lb.	4.35 ea.
173	10 lb.	5.40 ea.
174	12 lb.	6.50 ea.
175	16 lb.	8.65 ea.
BRASS		Retail
Cat. No.		
181	10 lb.	16.50 ea.
182	12 lb.	19.95 ea.
183	16 lb.	25.95 ea.

## CHAMPION SOLID IRON DUMBELLS

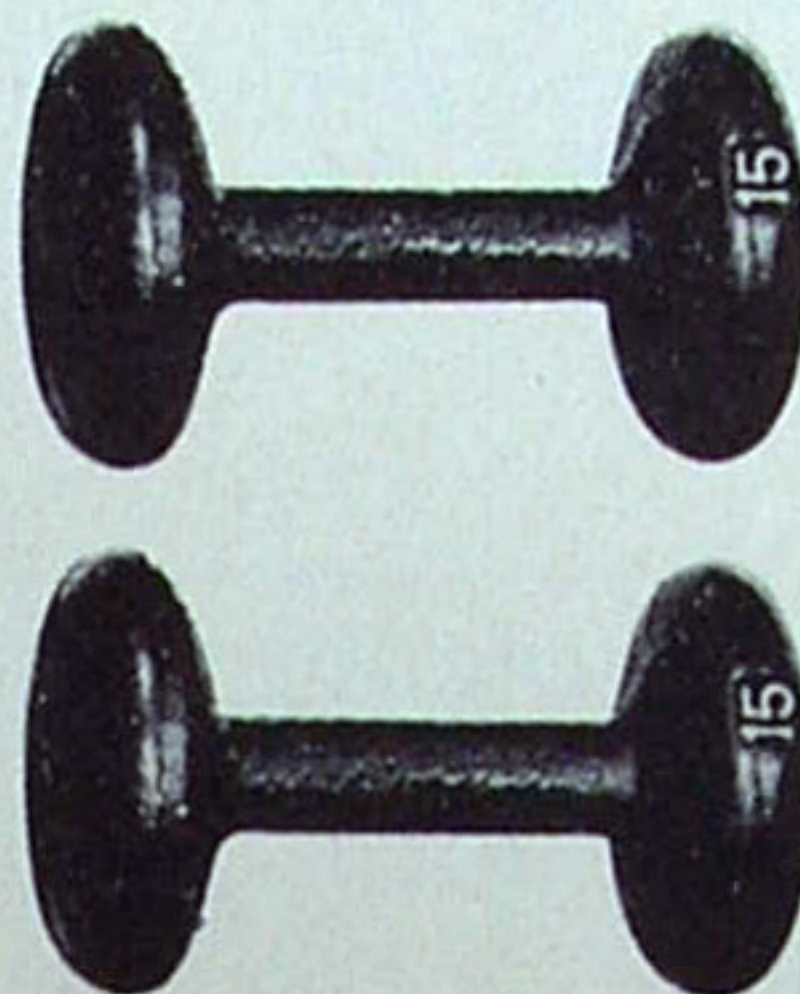

Cat. No.		Retail
127	1 lb.	.85 pr.
128	2 lb.	1.70 pr.
129	3 lb.	2.50 pr.
130	5 lb.	4.20 pr.
131	8 lb.	6.75 pr.
132	10 lb.	8.40 pr.
133	12 lb.	10.10 pr.
134	15 lb.	12.60 pr.
135	20 lb.	16.80 pr.

## CHAMPION BARBELL & DUMBBELL COMPONENTS AND REPLACEMENT PARTS

Cat. No.		Retail
142-01	12" Plain Bars (no sleeves or collars)	2.00 pr.
143-01	14" Plain Bars (no sleeves or collars)	2.00 pr.
142-03	Dumbbell Collars with Set Screws (Heavy Duty)	1.50 pr.
142-04	Dumbbell Wrench	.35 ea.
142-05	Set Screw for Dumbbell Collars	.10 ea.
142-06	Chrome Plated Dumbbell Sleeves	1.20 pr.
144-01	4' Plain Bar (no sleeve or collars)	2.75 ea.
145-01	5' Plain Bar (no sleeve or collars)	3.50 ea.
146-01	6' Plain Bar (no sleeve or collars) Spec. cold rolled steel	5.95 ea.
144-02	26 1/2" Chrome Plated Knurled Sleeve (fits 4' Bar)	4.00 ea.
145-02	34" Chrome Plated Knurled Sleeve (fits 5' Bar)	4.50 ea.
146-02	40" Chrome Plated Knurled Sleeve (fits 6' Bar)	5.00 ea.
145-03	Barbell Outside Collars (Hvy. Duty w/Handle Bolt Wrch)	2.50 pr.
145-04	Barbell Inside Collars (Heavy Duty) w/Set Screws	2.50 pr.
145-05	Handle Bolt Wrench for Barbell Inside Collars	.35 ea.
145-06	Set Screw for Barbell Inside Collars	.10 ea.

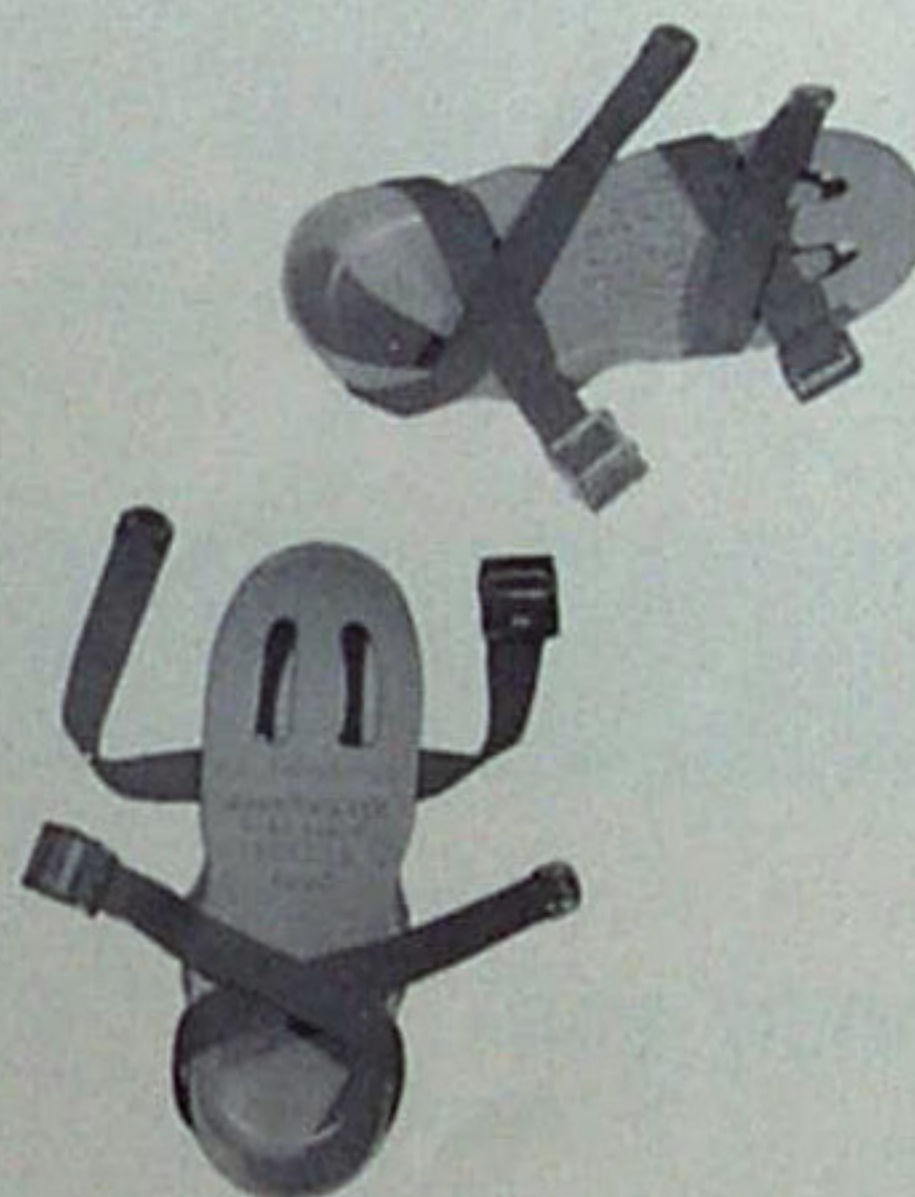

## HEALTH SHOE

Champions new exclusive design Iron Health Shoe (complete with instruction course) (includes 4 one inch web straps)

Cat. No. 161

Retail: \$5.95

## EXERCISING DEVICES



## HEALTH AND BEAUTY BELLES

Cash in on the growing popularity of these golden adjustable dumbbells for the ladies. Attractive, well packaged. Instructions included.

Wt. 10 lbs.

Retail \$9.95

Cat. No. 108

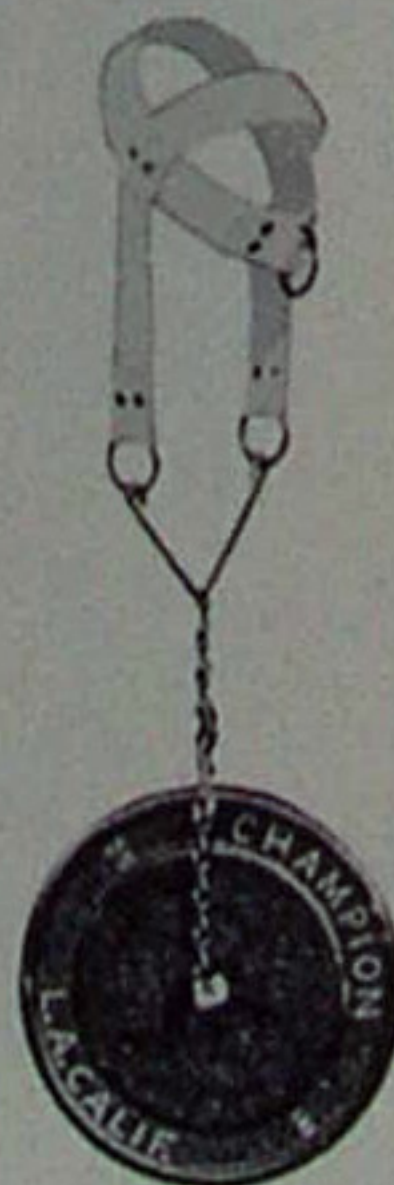

## CHAMPION HEADSTRAP

(complete with instruction course) Ideal for special neck development exercises with weight plates! Helps body builders complete their development program right along with the Barbell and Dumbbell Set!

Retail \$3.95 ea.

Cat. No. 163 Headstrap

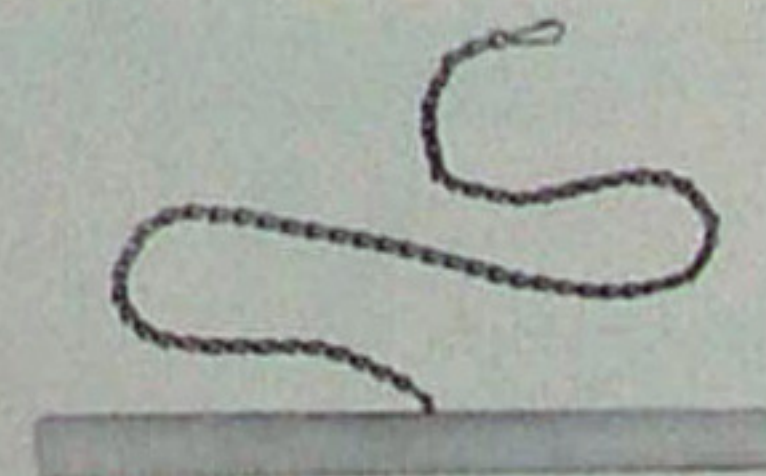

## CHAMPION WRIST AND FOREARM BUILDER

(complete with instruction course)

A simplified device that helps the body builder to develop the wrists and forearms . . . also used by athletes, coaches, baseball players and many others to achieve maximum strength and power!

Retail Price \$2.25

Cat. No. 164





## CHAMPION ROLL-AWAY EXERCISERS

Keep fit with the perfect exercises. Only 3 minutes a day puts you in shape. It can truly be said it is literally Iso-Metrics on wheels. A perfect group, family or individual exerciser. Scientifically designed, engineered, and constructed to meet exacting demands of every-day exercising equipment.  
**Cat. No. 208** **Retail Price \$6.95**

## THE CHAMPION BUILDER

New, re-designed, more durable, heavy tension rubber exerciser. Poly bagged with attractive display header!  
**Retail \$3.95**

Cat. No. 204

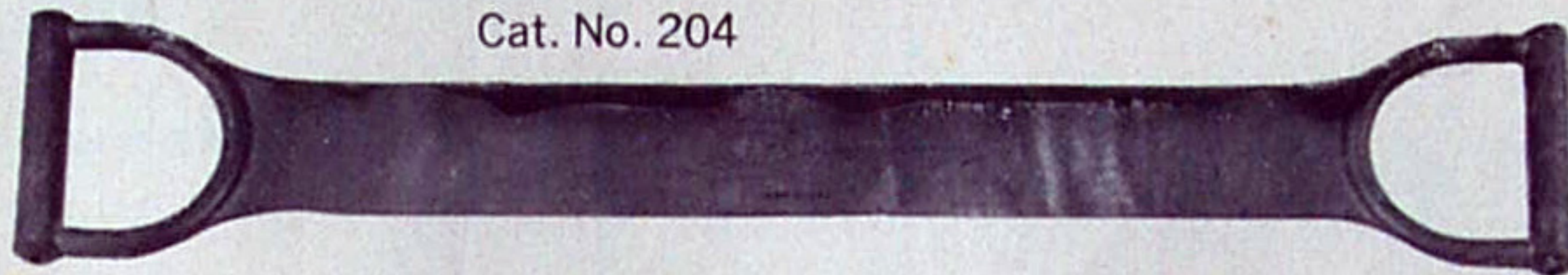

## THE CHAMPION CONDITIONER

New edge design, more comfortable finger wells, a more rugged rubber exerciser. Poly bagged with attractive display header.  
**Retail \$2.50**

Cat. No. 203



## X-ER-SIZE-OR DOOR BAR



Cat. No. 202

Featuring new fast installation chrome plated bar, rubber tipped, isometric exercise instruction course included, supports 300 pounds. Won't mar doorway. Two way fast adjustments.  
**Retail \$7.95**



## THE CHAMPION REACH TO HEALTH

The original Reach-to-Health, Rubber Rowing Machine Exerciser. Tried, tested and proven, the easy-to-use, convenient to carry and store, ideal, space-saving home exerciser for men, women, children, all ages! Only Champion offers the original Reach-to-Health package, now more attractive than ever before with new colorful Instruction Chart. America's leading Department Stores and Mail Order firms for 20 years have found the Reach-to-Health a year-in and year-out, year-round seller. Take advantage of the health and figure glamorizing fad that's sweeping the country. NOW is the time! Don't wait.

**Retail \$3.95**

Cat. No. 200



## THE CHAMPION GRIP

The ideal hand, finger, and wrist exerciser. Poly bagged with attractive display header.

**Retail \$1.00**

Cat. No. 205

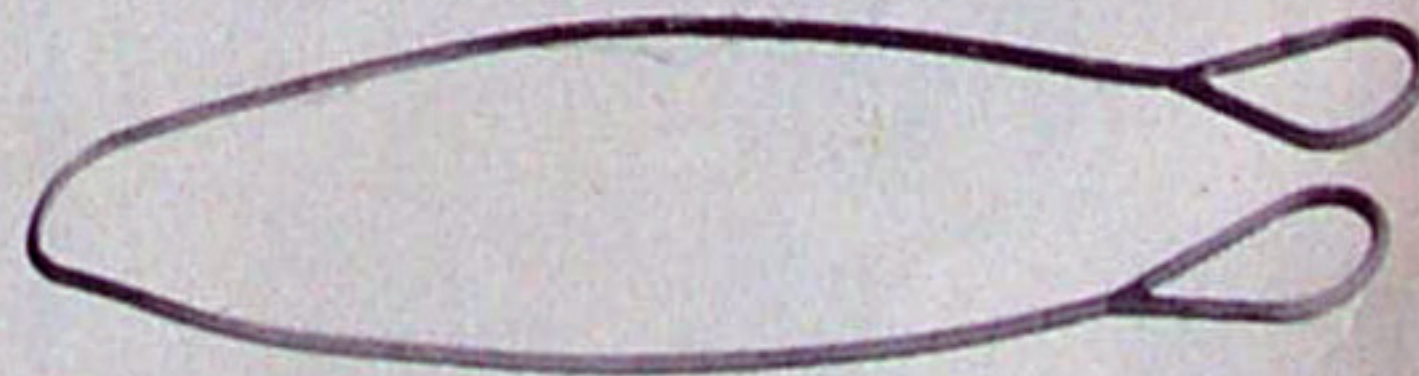

## THE CHAMPION STRETCH-ALL

America's newest rubber exercising conditioner for men, women and children — all ages! Fits over every door-knob, making it an ideal place for a home exercising program — offers a tremendous variety of upper body, posture, reducing and conditioning exercises! Comes complete with illustrated instruction chart that makes possible dozens of exercises for waistline, streamlining and general body-building for health, strength and vitality! Weighs but a few ounces. "Stretch-All" is an ideal easy-to-use, pocket size storage, all around exerciser for home, trips, vacations! Champion's "Stretch-All" is one of the best, popular priced promotional exercising devices every made! Individually packaged.

**Retail \$1.98**

Cat. No. 201



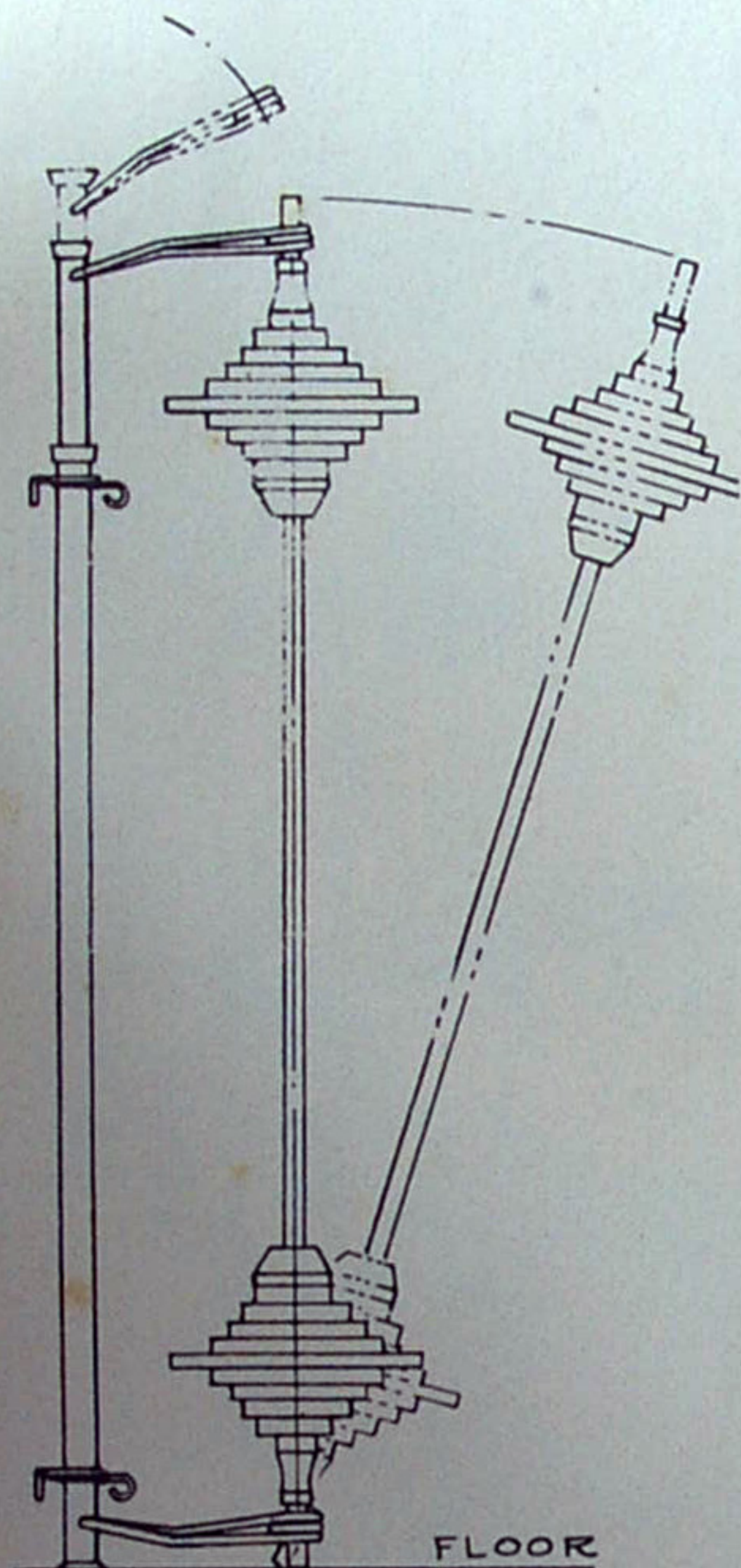

## CHAMPION HOME BARBELL RACK

New — no other like it. Adjustable telescopic mounts in any corner — All hardware furnished, instructions on how to install. Any barbell will fit into rack — keeps barbell upright and off the floor.

Retail \$4.95

Cat. No. 186

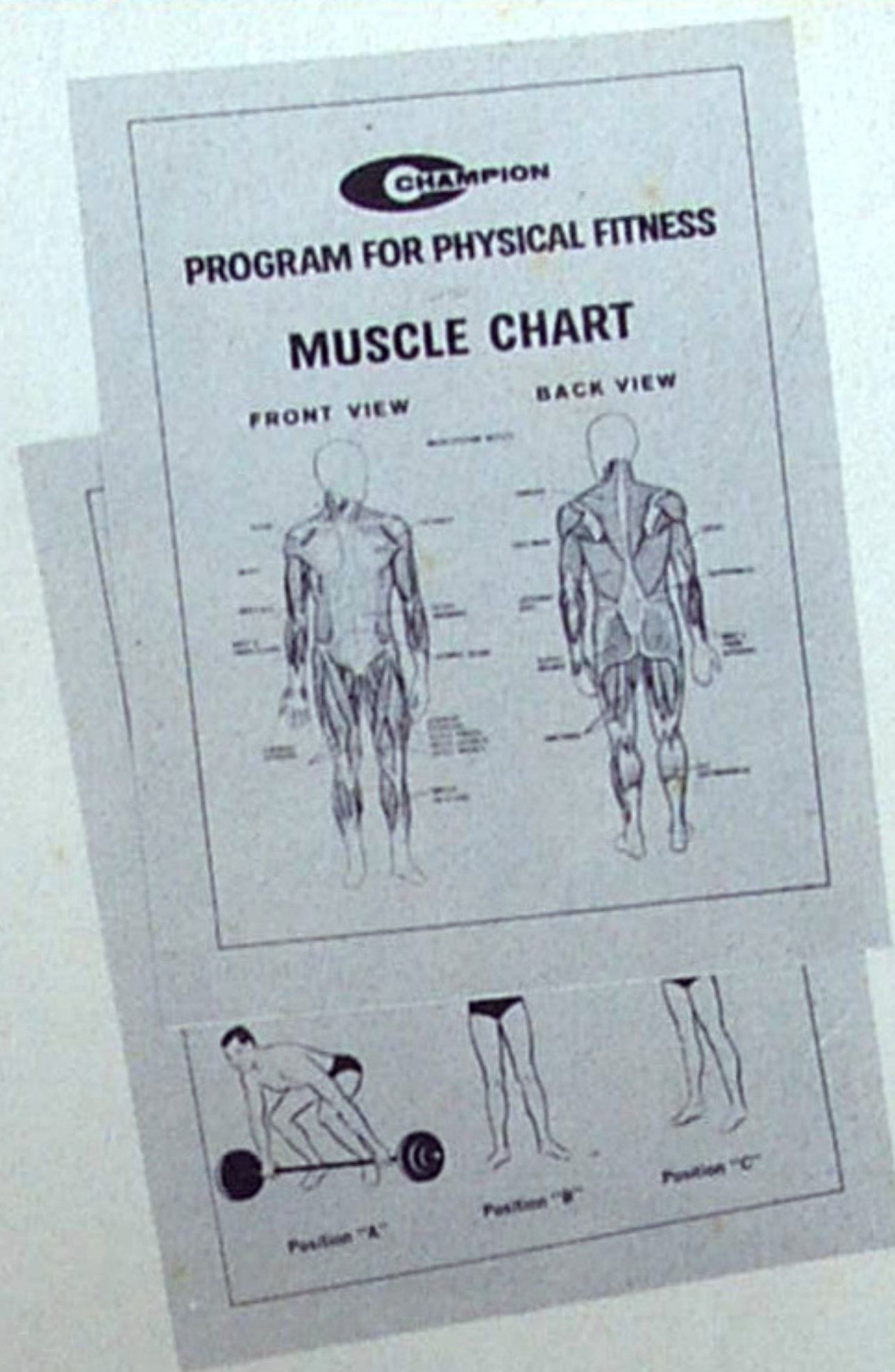

## CHAMPION STREAMLINED COMBINATION SET

New Streamlined Champion Barbell. The all new Champion 110 lb. Promotional Combination set featuring new look in Barbells, includes: 110 lb. Barbell, one pair 14" Dumbbell Bars, one Dumbbell Wrench, 11 easy to read work-out charts, new easy to read illustrated Barbell and Dumbbell routine book, the new Home Barbell Rack. Old fashioned collars eliminated. The set features Champion's new CUP-COLLARS, permits use of more weight on standard 5' bar for perfect balance. Barbell collars can be utilized on 14" Dumbbell bars to make a bell type 22 lb. dumbbell set. Cat. No. 106 .....Retail \$29.95

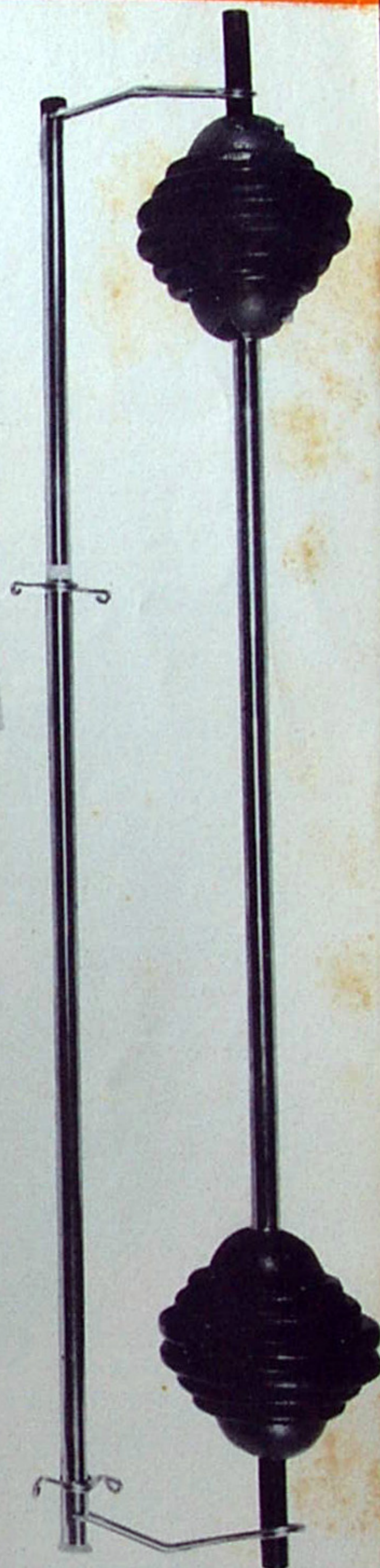
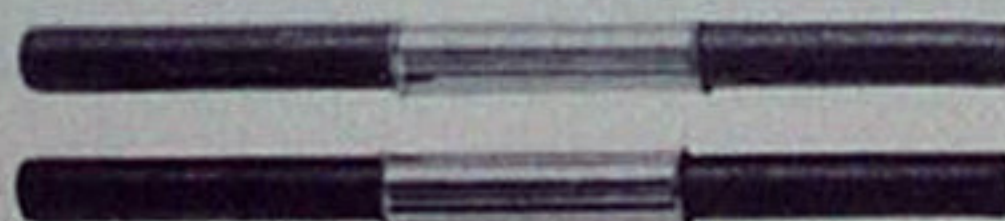

## CHAMPION ISO-HOME-GYM INSTRUCTION BOOK

Easy to read, easy to follow instructions—many Isometric routines with variations—combined with a dumbbell course.

Retail \$1.00

Cat. No. 220-10

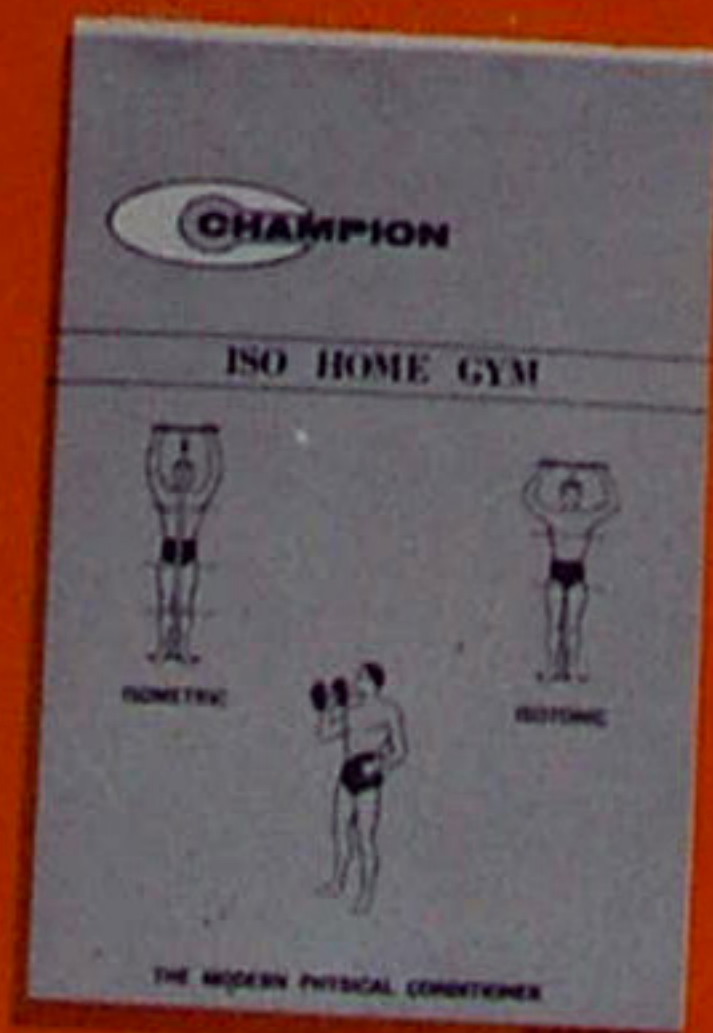

## CHAMPION BARBELL & DUMBELLS BOOKS

New easy to read, illustrations easy to follow. Step by step routines, major muscles used. Sleep, diet, exercise periods explained. A must for any one using weightlifting equipment.

Retail \$1.00

Cat. No. 101-9





## ABDOMINAL BOARD (Slant Board)

Cat. No. 211

New adjustable, foam padded, scuff resistant, 27 oz. Leatherette, heavy web foot strap, quick easy chrome adjustable legs from floor adjustment to 18" in height. "Quicklok" type collars, no wrench necessary. Shipping Wt. 25 lbs.

Retail \$19.95 f.o.b. Los Angeles

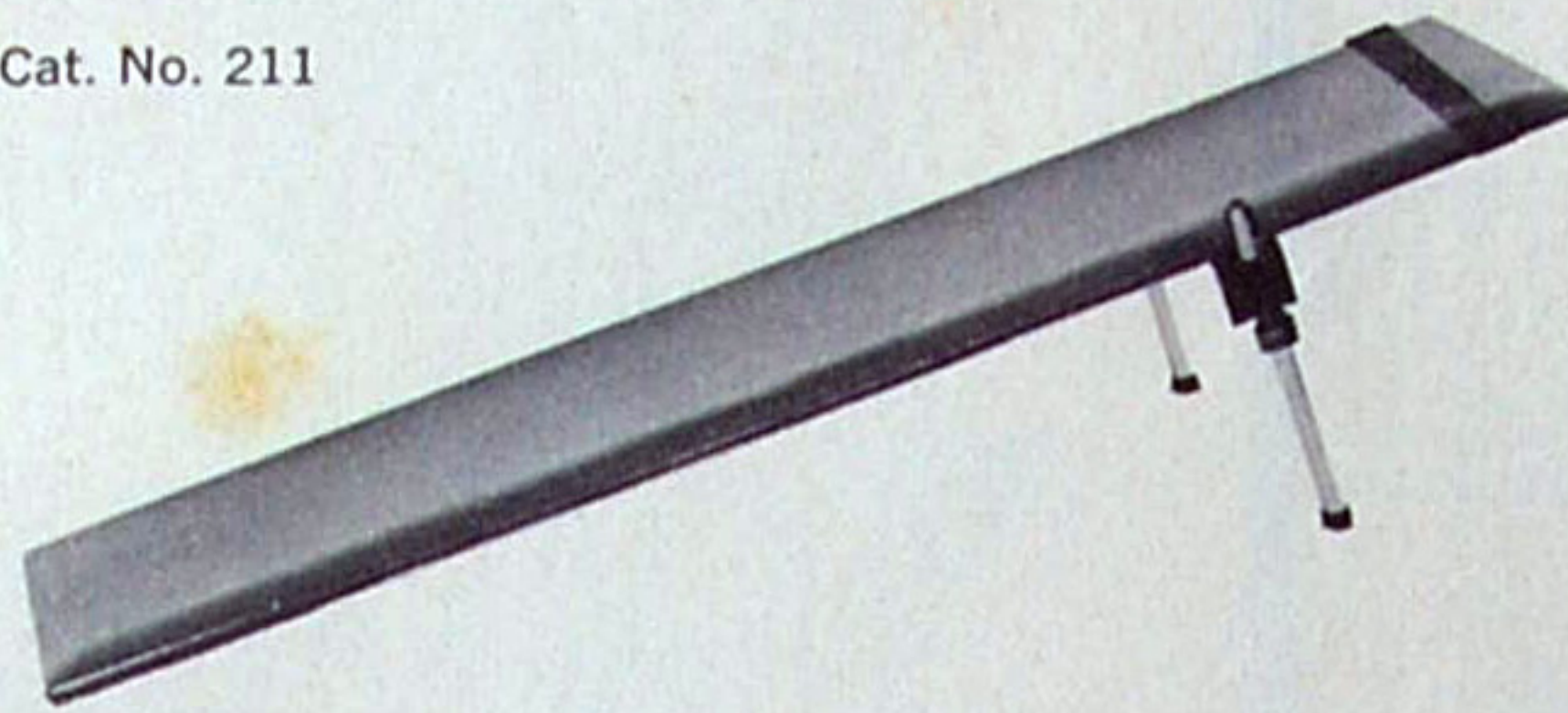

## THE BIG NEW 6-IN-1 COMBINATION BENCH

Cat. No. 209

The 6-in-1 Combination Bench is a low cost, multiple-purpose exercise unit that incorporates 6 separate pieces of popular exercise equipment. You can handle weights up to 350 lbs. with this combination bench. An extremely compact and portable gym. Featuring: Adjustable Dipping Rack, Adjustable width Supine Press Racks, Adjustable Squat Rack, Flat Exercise Bench, Abdominal Board, Adjustable Inclined Bench. Luxurious shiny black and chrome finish. Durable welded steel construction. Uprights are adjustable to 55" in height, from 12" to 27" in width. Bench top is 1-ply Polyfoam padded and covered with attractive Eggshell or Red Leatherette. Storing floor space: 12" x 48". Shipping weight 50 lbs.

Retail \$44.95 (f.o.b. Los Angeles)

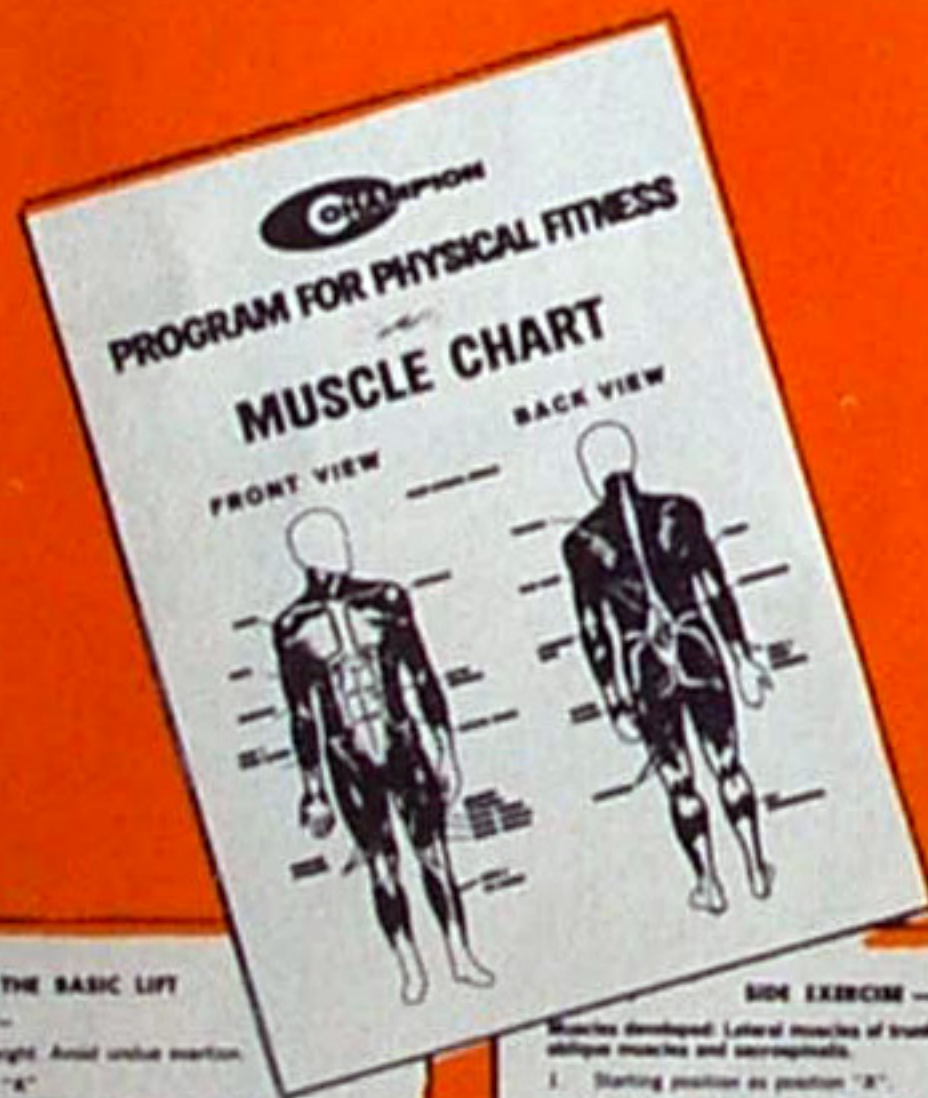

## CHAMPION WALL CHARTS

New Champion wall charts featuring illustrated easy to read and follow instructions; ideal for the home or institutional workout room. Easy to read muscle front and rear views showing major muscles utilized in the work-out. 17" x 22" in size. Group of 11 charts featuring many variations.

Cat. No. 153

(Set of 11) Retail \$4.95

<p><b>THE BASIC LIFT</b></p> <p>Warning up exercise --</p> <ol style="list-style-type: none"> <li>Use moderate weight. Avoid undue exertion.</li> <li>Assume position "A".</li> <li>Grasp bar palms downward, shoulder width.</li> <li>Pull barbell from floor to overhead position in one continuous motion, keeping back straight. Motion completed as shown in position "B".</li> <li>Repeat ten times.</li> <li>This exercise should precede all other exercises.</li> </ol> <p>Position "A"      Position "B"</p>	<p><b>SIDE EXERCISE</b></p> <p>Muscles developed: Lateral muscles of trunk, external and internal oblique muscles and sacrospinalis.</p> <ol style="list-style-type: none"> <li>Starting position as in position "A".</li> <li>Stand at legs as far as possible to left. See position "B". Return to position "A".</li> <li>Repeat to right side and return.</li> <li>Repeat ten times.</li> <li>Later this exercise may be attempted in one continuous circular motion.</li> <li>Another variation is as shown in position "C" -- one handed.</li> </ol> <p>Position "A"      Position "B"      Position "C"</p>	<p><b>DEAD LIFT -- STIFF LEGGED</b></p> <p>Muscles developed: Extensor muscles of the back, Sacrospinalis, anterior of thighs and knees, quadriceps extensors and gluteus maximus.</p> <ol style="list-style-type: none"> <li>Starting position as in position "A".</li> <li>Move to position "B".</li> <li>Place heels together, legs stiff. See position "B".</li> <li>Lower weight to floor legs stiff then raise again to position "B" before when lifting, exhale when lowering.</li> <li>Repeat ten times.</li> </ol> <p>Position "A"      Position "B"</p>	<p><b>BOWING EXERCISE OR PULL-UP TO CHEST</b></p> <p>Muscles developed: Upper back and upper arms, trapezius, rhomboids, deltoids, biceps and brachialis.</p> <ol style="list-style-type: none"> <li>Starting as shown in position "A" with legs slightly bent, keep the back flat in a horizontal position.</li> <li>Keep elbows bent. Pull weight to chest as in position "B". Lower to straight arms and repeat eight times.</li> <li>This is an arm exercise. Use only arms.</li> </ol> <p>Position "A"      Position "B"</p>	<p><b>STRADDLE LIFT -- LEG EXERCISE</b></p> <p>Muscles developed: Leg muscles, thigh and lower leg extensors, gluteus maximus, quadriceps extensors and sacrospinalis.</p> <ol style="list-style-type: none"> <li>Starting position as in position "A". Legs eighteen inches apart, hands close to the body and on bar, thumbs forward, back straight.</li> <li>Move to position "B".</li> <li>To exercise keep back straight, body upright, bend legs, lowering body six to eight inches to position "C". Return to position "B".</li> <li>Repeat ten times.</li> <li>Work only with legs.</li> </ol> <p>Position "A"      Position "B"      Position "C"</p>
<p><b>PRESS -- BEHIND NECK</b></p> <p>Muscles developed: upper back and shoulders.</p> <ol style="list-style-type: none"> <li>Starting position as shown in position "A".</li> <li>Hands six inches further apart than shoulder width.</li> <li>Place barbell on shoulder. Position "A".</li> <li>Press as shown in position "B" and arms are fully extended above head. See position "C".</li> <li>Lower and repeat eight times.</li> </ol> <p>Position "A"      Position "B"      Position "C"</p>	<p><b>TWO HAND CURL</b></p> <p>Muscles developed: Biceps, Arms, Shoulders, Upper back</p> <ol style="list-style-type: none"> <li>Starting position as in position "A".</li> <li>Stand erect, arms forward, shoulders back, elbows in and stationary.</li> <li>Bring weight to chest in one movement by flexing elbows as in position "B", return to position "A".</li> <li>Use less weight than in the Two Hand Press. Exercise slowly. Use only arm strength -- not the back.</li> <li>Repeat ten times.</li> <li>A variation of the two hand curl is the reverse curl. See position "C". Repeat eight times.</li> </ol> <p>Position "A"      Position "B"      Position "C"</p>	<p><b>TWO HAND PRESS</b></p> <p>Muscles developed: Triceps, Deltoids</p> <ol style="list-style-type: none"> <li>Starting position -- see position "A". Pull bar to chest, STOP. See position "B".</li> <li>Legs straight, back straight, arms forward.</li> <li>Push barbell over head. See position "C".</li> <li>Use only enough weights to cause slight exertion during four repetitions.</li> <li>Repeat ten times.</li> <li>Variation -- Sit down press -- using bench.</li> </ol> <p>Position "A"      Position "B"      Position "C"</p>	<p><b>TWO ARM SNATCH</b></p> <p>Over all body development and coordination</p> <ol style="list-style-type: none"> <li>Starting position as in warm-up. See position "A".</li> <li>Pull weight overhead, bar close to body, snap wrists and lock under bar at top of lift. Position "B".</li> <li>Move to position "C". Feet parallel, body under bar, back arched.</li> <li>Return weight to starting position.</li> <li>Repeat five to eight times. Eyes forward.</li> </ol> <p>Position "A"      Position "B"      Position "C"</p>	<p><b>CLEAN AND JERK</b></p> <p>Use maximum weight.</p> <ol style="list-style-type: none"> <li>Starting position as used in warming up exercise. See position "A".</li> <li>"Clean" the weight to position "B" using basic lift, dropping to squat position as elbows are raised under and up. Rise with barbell at shoulder height.</li> <li>With one leg slightly forward, bend knees slightly. Push weight straight overhead with a strong thrust of both legs. Catcher Position "C". Eyes forward, body erect.</li> <li>Lock elbows, feet parallel as in position "C".</li> <li>Return barbell slowly to shoulders.</li> <li>Repeat five to eight times.</li> <li>Basic Olympic lift.</li> </ol> <p>Position "A"      Position "B"      Position "C"</p>



# PLANT LOCATIONS

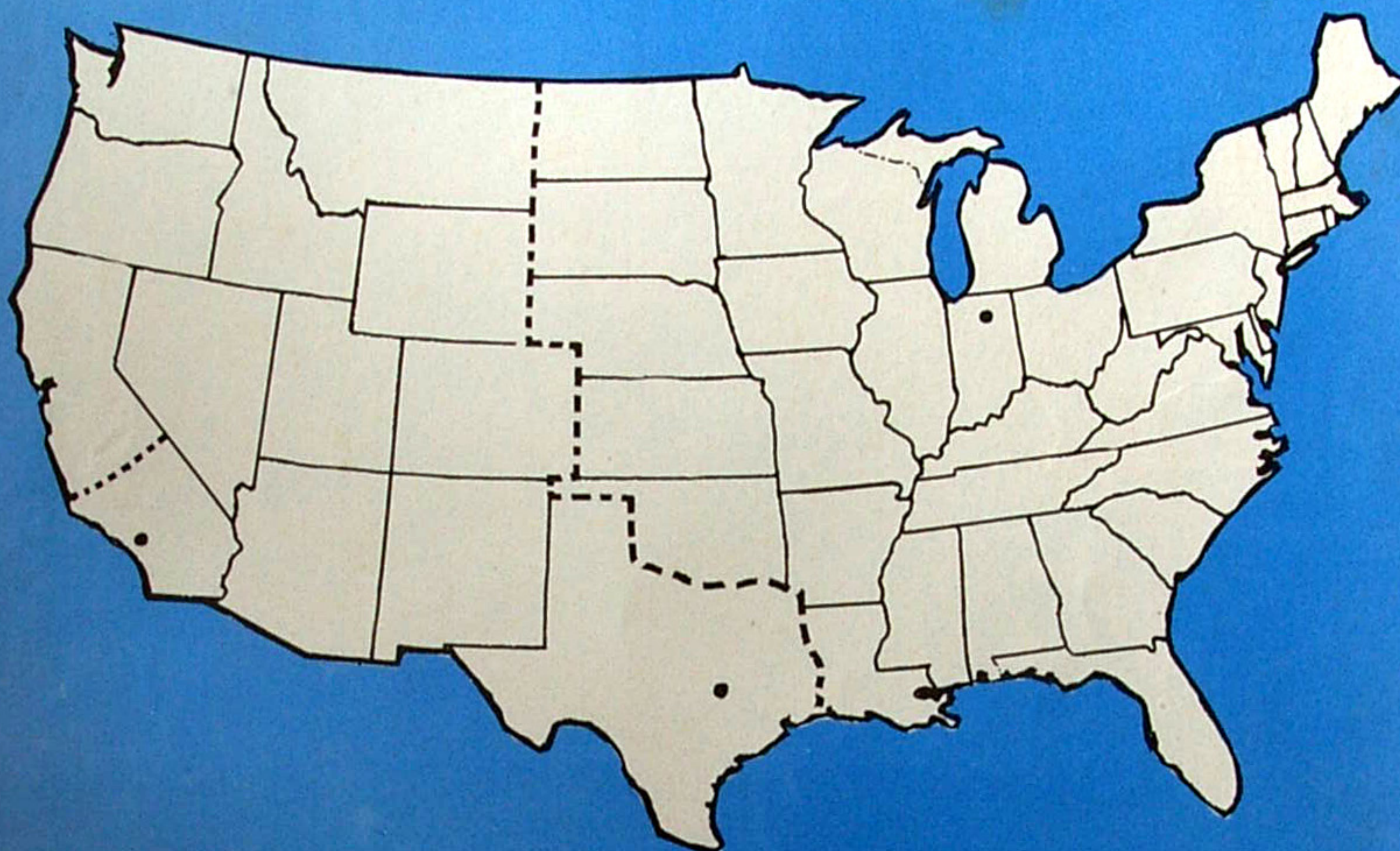

## CHAMPION EXERCISERS, INC.

### AMERICA'S FINEST BARBELLS — DUMBELLS — EXERCISING DEVICES

CHAMPION, INC. Barbell manufacturing plants in Los Angeles, California, Warsaw, Indiana and Hearne, Texas are ideally located to service accounts through the United States.

F.O.B. CHAMPION, INC., Los Angeles

F.O.B. CHAMPION, INC., Warsaw, Ind.

F.O.B. CHAMPION, INC., Hearne, Texas

It is suggested that Dealers order minimum 500 lb. shipments in order to effect greatest freight savings due to present minimum freight charges by many carriers. Please check with your local freight carriers to determine if you can effect further savings on smaller or larger shipments.

Specified freight allowance in each area will be deducted from the face of the invoice at time of shipment.

## PLEASE AIR MAIL ORDERS FOR QUICKEST SERVICE

**NOTE:** A 10% freight allowance will be given on all shipments made to the following areas: Alaska, Hawaii and all Pacific areas, Canada, Mexico, Central America and the Caribbean areas.

**EXPORT PACKING:** a 48½c per cu. ft. charge will be made for wood crating, double steel strapped. Additional charge of 5c per cu. ft. for waterproof lining.

**CHAMPION RESERVES THE RIGHT TO PREPAY SHIPMENT WITHOUT ANY FREIGHT ALLOWANCE.**

**IMPORTANT:** CHAMPION prepays freight on special combined Pool Car and partial Pool Car shipments from time to time as they are made by special arrangement. Write for information or telephone for details.



**THE WORLD'S MOST ADVANCED  
DIVING EQUIPMENT**

